



McIntosh Laboratory, Inc. 2 Chambers Street Binghamton, New York 13903-2699 Phone: 607-723-3512 [www.mcintoshlabs.com](http://www.mcintoshlabs.com)

## MC312

Power Amplifier

Owner's Manual





Important Safety Information is supplied in a separate document "Important Additional Operation Information Guide"

### Thank You

Your decision to own this McIntosh MC312 Stereo Power Amplifier ranks you at the very top among discriminating music listeners. You now have "The Best." The McIntosh dedication to "Quality," is assurance that you will receive many years of musical enjoyment from this unit.

Please take a short time to read the information in this manual. We want you to be as familiar as possible with all the features and functions of your new McIntosh.

### Please Take A Moment

The serial number, purchase date and McIntosh Dealer name are important to you for possible insurance claim or future service. The spaces below have been provided for you to record that information:

Serial Number: \_\_\_\_\_

Purchase Date: \_\_\_\_\_

Dealer Name: \_\_\_\_\_

### Technical Assistance

If at any time you have questions about your McIntosh product, contact your McIntosh Dealer who is familiar with your McIntosh equipment and any other brands that may be part of your system. If you or your Dealer wish additional help concerning a suspected problem, you can receive technical assistance for all McIntosh products at:

McIntosh Laboratory, Inc.  
2 Chambers Street  
Binghamton, New York 13903  
Phone: 607-723-3512  
Fax: 607-724-0549

### Customer Service

If it is determined that your McIntosh product is in need of repair, you can return it to your Dealer. You can also return it to the McIntosh Laboratory Service Department. For assistance on factory repair return procedure, contact the McIntosh Service Department at:

McIntosh Laboratory, Inc.  
2 Chambers Street  
Binghamton, New York 13903  
Phone: 607-723-3515  
Fax: 607-723-1917

### Table of Contents

Safety Instructions.....	2
(Separate Sheet) .....	<b>Important Additional</b>
	<b>Operation Information Guide</b>
Thank You and Please Take a Moment.....	2
Technical Assistance and Customer Service .....	2
Table of Contents .....	2
General Information .....	2
Connector and Cable Information .....	3
Introduction.....	3
Performance Features .....	3
Dimensions .....	5
Installation .....	6
Rear Panel Connections and Switch .....	7
Output Terminals and How to Connect .....	8-9
Output Terminals and How to Connect for Bi-Amp .....	10-11
Front Panel Displays and Controls.....	12
How to Operate.....	13
Technical Description .....	14-17
Specifications.....	18
Packing Instruction.....	19

### General Information

1. For additional connection information, refer to the owner's manual(s) for any component(s) connected to the MC312.
2. The MC312 mutes the speaker output for approximately two seconds when first turned on.
3. For the best performance and safety it is important to always match the impedance of the Loudspeaker to the Power Amplifier connections. Refer to "How to Connect" pages 7 thru 10.

*Note: The impedance of a Loudspeaker actually varies as the Loudspeaker reproduces different frequencies. As a result, the nominal impedance rating of the Loudspeaker (usually measured at a midrange frequency) might not always agree with the impedance of the Loudspeaker at low frequencies where the greatest amount of power is required. Contact the Loudspeaker Manufacturer for additional information about the actual impedance of the Loudspeaker before connecting it to the McIntosh MC312.*

4. In the event the MC312 over heats, due to improper ventilation and/or high ambient temperature, the protection circuits will activate. The Front Panel Power Guard LED will continuously indicate ON and the audio will be muted. When the MC312 has returned to a safe operating temperature, normal operation will resume.
5. When discarding the unit, comply with local rules or regulations. Batteries should never be thrown away or incinerated but disposed of in accordance with the local regulations concerning battery disposal.
6. For additional information on the MC312 and other McIntosh Products please visit the McIntosh Website at [www.mcintoshlabs.com](http://www.mcintoshlabs.com).



## Connector and Cable Information

### XLR Connectors

Below is the Pin configuration for the XLR Balanced Input, Input/Output Connectors on the MC312. Refer to the diagram for connection:

- PIN 1: Shield/Ground
- PIN 2: + Input/Output
- PIN 3: - Input/Output

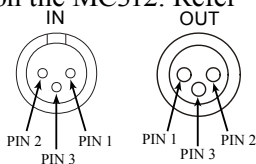

### Power Control Connector

The MC312 Power Control Input receives an On/Off signal from +5 to +12 volts. The Power Control Output will in turn provide a +12 volt Output Signal with a total current up to 50mA. An additional connection is for controlling the illumination of the MC312 Power Output Meters. The 1/8 inch stereo mini phone plug connects to a McIntosh Preamplifier or A/V Control Center Power Control Output.

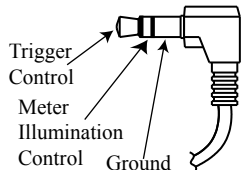

### Output Terminal Connector

When cables with spade lugs are used for Loudspeaker Connection, the spade lugs need an opening of at least 3/10 inch (7.6mm).

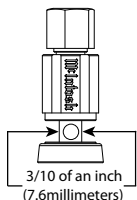

## Introduction

Now you can take advantage of traditional McIntosh standards of excellence in the MC312 Power Amplifier. The 300 watts power per channel with high current output will drive any pair of high quality Loudspeakers. The MC312 reproduction is sonically transparent and absolutely accurate. The McIntosh Sound is “The Sound of the Music Itself.”

## Performance Features

### • Power Output

The MC312 is a Power Amplifier with a capability of 300 watts per channel into 2, 4 or 8 ohm speakers with less than 0.005% distortion. The Power Amplifier Circuitry uses ThermalTrak<sup>1</sup> Output Transistors for lower distortion and cool operation.

### • Patented Autoformer

McIntosh designed and manufactured Output Autoformers provide an ideal match between the amplifier output stages and speaker loads of 2, 4 and 8 ohms. The Autoformers also provide perfect DC protection for your valuable loudspeakers.

### • Balanced and Unbalanced Inputs

Balanced connections guard against induced noise and allow long cable runs without compromising sound quality.

### • Power Guard

The patented McIntosh Power Guard circuit prevents the amplifier from being over driven into clipping, with its harsh distorted sound that can also damage your valuable loudspeakers.

### • Sentry Monitor and Thermal Protection

McIntosh Sentry Monitor power output stage protection circuits ensure the MC312 will have a long and trouble free operating life. Built-in Thermal Protection Circuits guard against overheating.

### • Special Power Supply

A very large Power Transformer and Large Capacitors ensure stable noise free operation even though the power line varies.

<sup>1</sup> ThermalTrak™ and ON Semiconductor are trademarks of Semiconductor Components Industries, LLC

### • Illuminated Power Meters

The Illuminated Power Output Watt Meters on the MC312 are peak responding, and indicate the true power output of the amplifier. The Peak Watt Hold Mode allows the meter to temporarily stay at the highest power output and then slowly decay. The Front Panel Meter Illumination may be switched Off at any time.

### • McIntosh Custom Binding Posts

McIntosh patent pending gold plated output terminals deliver high current output. They accept large diameter wire and spade lugs. Banana plugs may also be used only in the United States and Canada.

### • Glass Front Panel and Super Mirror Chassis Finish

The famous McIntosh Illuminated Glass Front Panel uses long life Light Emitting Diodes (LEDs) and the Stainless Steel Chassis with Super Mirror Finish ensures the pristine beauty of the MC312 will be retained for many years.



### Dimensions

The following dimensions can assist in determining the best location for your MC312.

#### Front View of the MC312

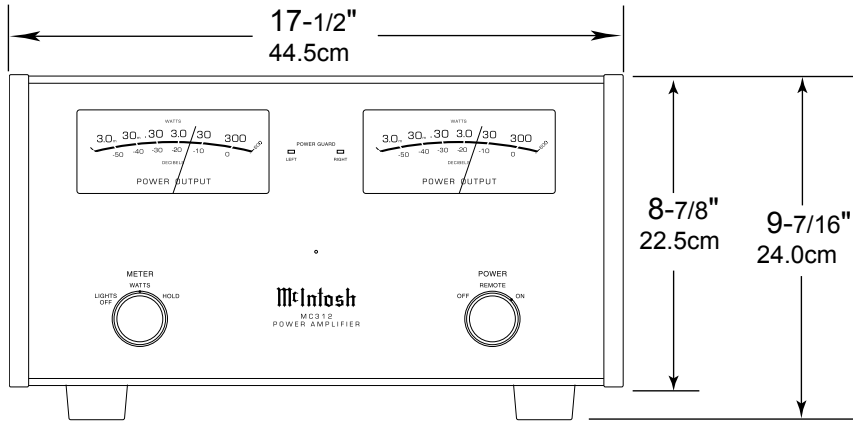

#### Rear View of the MC312

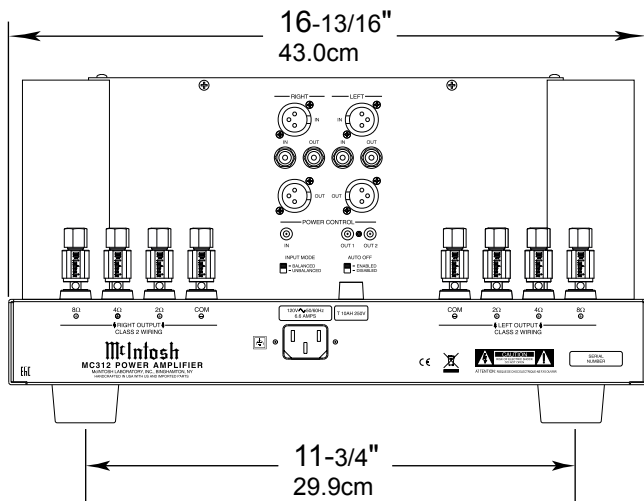

#### Side View of the MC312

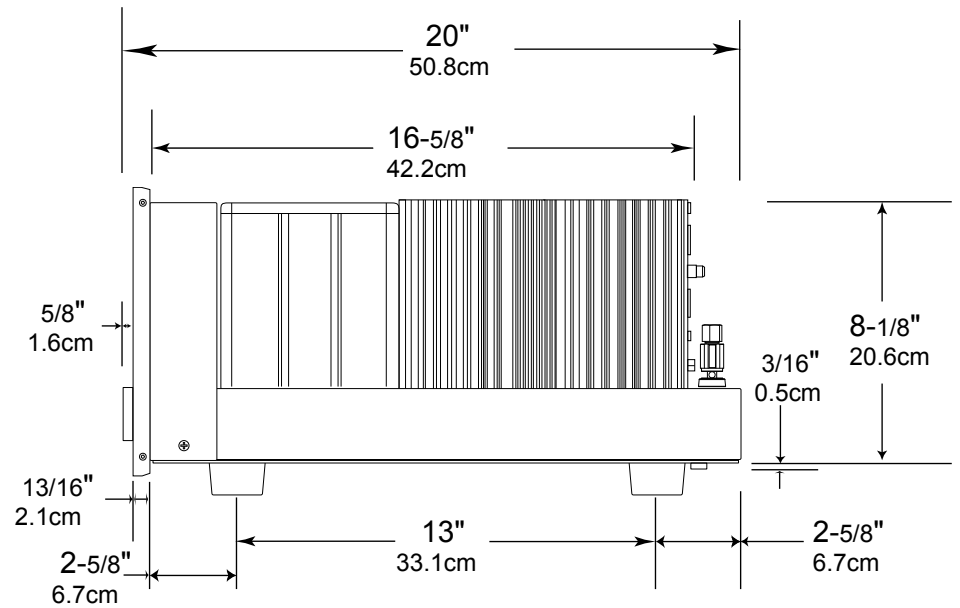

## Installation

The MC312 can be placed upright on a table or shelf, standing on its four feet. It also can be custom installed in a piece of furniture or cabinet of your choice. The four feet may be removed from the bottom of the MC312 when it is custom installed as outlined below. The four feet together with the mounting screws should be retained for possible future use if the MC312 is removed from the custom installation and used free standing. The required panel cutout, ventilation cutout and unit dimensions are shown.

Always provide adequate ventilation for your MC312. Cool operation ensures the longest possible operating life for any electronic instrument. Do not install the MC312 directly above a heat generating component such as a high powered amplifier. If all the components are installed in a single cabinet, a quiet running ventilation fan can be a definite asset in maintaining all the system components at the coolest possible operating temperature.

A custom cabinet installation should provide the following minimum spacing dimensions for cool operation.

Allow at least 6 inches (15.24cm) above the top, 2 inches (5.08cm) below the bottom, 3 inches (7.62cm) behind the rear panel and 2 inches (5.08cm) on each side of the Power Amplifier, so that airflow is not obstructed. Allow 7/8 inch (2.22cm) in front of the mounting<sup>1</sup> panel for clearance. **Be sure to cut out a ventilation hole in the mounting shelf according to the dimensions in the drawing.**

<sup>1</sup> When the MC312 is installed together with other McIntosh Components, check clearances on all components before proceeding.

**MC312 Front Panel Custom Cabinet Cutout**

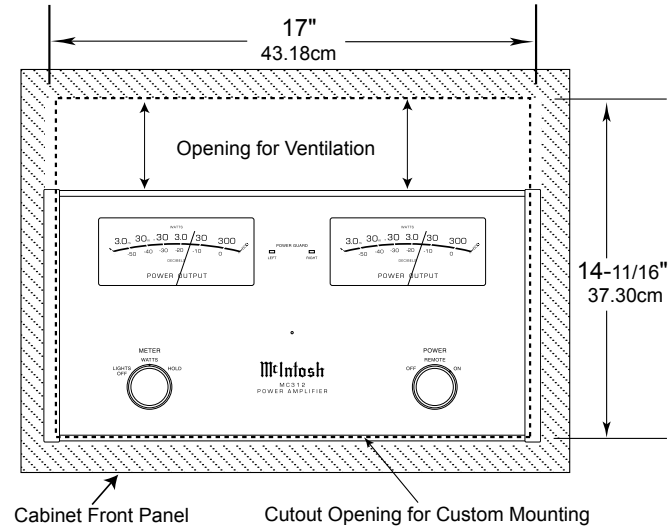

**MC312 Side View in Custom Cabinet**

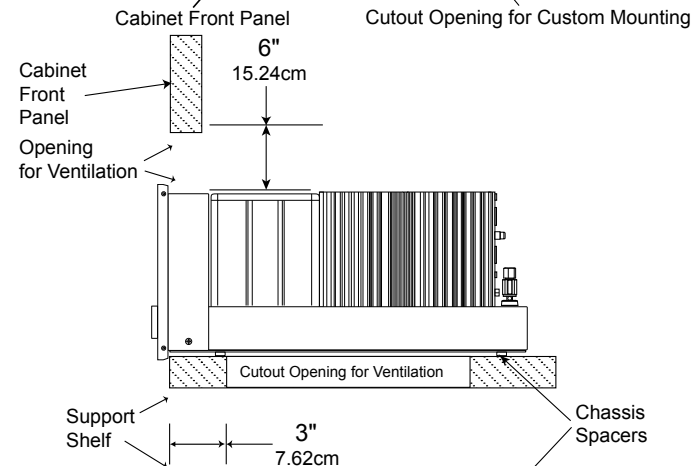

**MC312 Bottom View in Custom Cabinet**

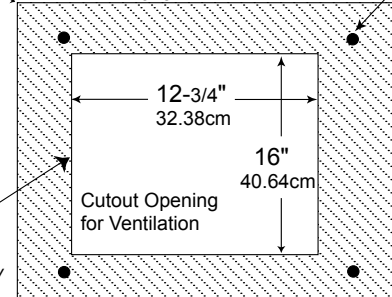

Note: Center the cutout horizontally on the unit. For purposes of clarity, the above illustration is not drawn to scale.



# Rear Panel Connections and Switch

Balanced OUTputs (LEFT and RIGHT Channels) for an audio cable to the next Power Amplifier Input

INPUT MODE switch selects between BALANCED or UNBALANCED Inputs

Unbalanced INput (RIGHT Channel) for an audio cable from a Preamplifier or A/V Control Center audio output.  
Unbalanced OUTput (RIGHT Channel) for an audio cable to the next Power Amplifier Input

Balanced INputs (LEFT and RIGHT Channels) for audio cables from a Preamplifier or A/V Control Center audio output

Unbalanced INput (LEFT Channel) for an audio cable from a Preamplifier or A/V Control Center audio output.  
Unbalanced OUTput (LEFT Channel) for an audio cable to the next Power Amplifier Input

POWER CONTROL IN receives turn On/Off signals from a McIntosh component.  
POWER CONTROL OUT 1 and 2 send turn On/Off signals to the next McIntosh Component

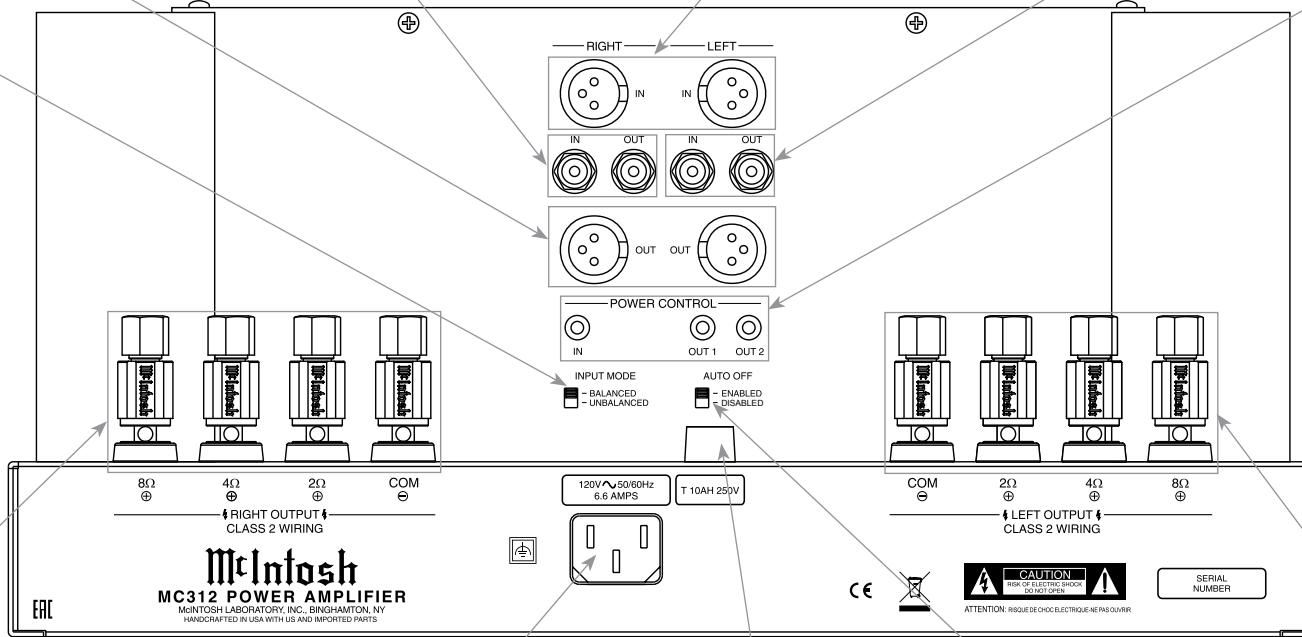

RIGHT OUTPUT Connections for a 2 ohm, 4 ohm or 8 ohm Loudspeaker

Fuse holder, refer to information on the rear panel of your MC312 to determine the correct fuse size and rating

LEFT OUTPUT Connections for a 2 ohm, 4 ohm or 8 ohm Loudspeaker

Connect the MC312 power cord to a live AC outlet. Refer to the rear panel to determine the correct voltage

AUTO OFF Mode Switch selects between ENABLED or DISABLED

## Output Terminals

When connecting the Loudspeaker Hookup Cables to the MC312 Power Amplifier Output Terminals please follow the steps below:

1. Rotate the top of the Output Terminal Post counterclockwise until an opening appears. Refer to figures A and B.
2. Insert the Loudspeaker hookup cable into the Output Terminal Post opening or the cable spade lug around the center post of the Output Terminal. Refer to figure C.
3. Rotate the top of the Output Terminal Post clockwise until it is finger tight. Refer to figure D.
4. Place the supplied McIntosh Wrench over the top of the Output Terminal and rotate it one quarter of a turn (90°) to secure the Loudspeaker Cable Connection. **Do not over tighten.** Refer to figure E.

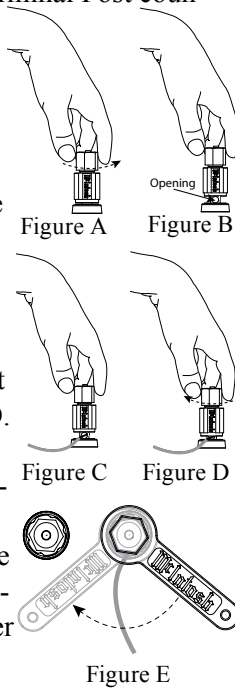

## How to Connect

**Caution: Do not connect the AC Power Cord to the MC312 Rear Panel until after the Loudspeaker Connections are made. Failure to observe this could result in Electric Shock.**

The connection instructions below, together with the MC312 Connection Diagram located on the separate folded sheet “Mc1A”, is an example of a typical audio system. Your system may vary from this, however the actual components would be connected in a similar manner. For additional information refer to “Connector and Cable Information” on page 3.

1. For Remote Power Control, connect a power control cable from the Audio Preamplifier or A/V Control Center Power Control Output 1 to the MC312 POWER CONTROL IN.

*Notes: 1. When a Power Control Cable is connected between the MC312 and Preamplifier (or A/V Control Center), the AUTO OFF Feature is bypassed. Refer to page 13.*

2. When the MC312 has Loudspeakers connected to it with a Power Control Input, connect the MC312 Power Control Out 1 and Out 2 to the Loudspeakers.

2. Connect XLR cables from the Balanced Output 1 (L&R) of an Audio Preamplifier or A/V Control Center to the MC312 Balanced INPUT (RIGHT and LEFT). Place the INPUT MODE Switch in the BALANCED Position.

*Note: An optional hookup is to use unbalanced cables and place the INPUT MODE Switch in the UNBALANCED Position.*

This McIntosh MC312 Power Amplifier is designed for Loudspeakers with an impedance of 2 ohms, 4 ohms or 8 ohms. Connect a single Loudspeaker only to the Right and Left Output Terminals.

When connecting Loudspeakers to the MC312 it is very important to use cables of adequate size, so there is little to no power loss in the cables. The size is specified in Gauge Numbers or AWG (American Wire Gauge). The smaller the Gauge number, the larger the wire size:

Loudspeaker Cable Distance vs Wire Gauge Guide			
Loudspeaker Impedance	25 feet (7.62 meters) or less	50 feet (15.24 meters) or less	100 feet (30.48 meters) or less
2 Ohms	12AWG	10AWG	8AWG
4 Ohms	14AWG	12AWG	10AWG
8 Ohms	16AWG	14AWG	12AWG

3. Prepare the Loudspeaker Hookup Cable for attachment to the MC312 Power Amplifier:

### Bare wire cable ends:

Carefully remove sufficient insulation from the cable ends, refer to figures 2, 3 & 4. If the cable is stranded, carefully twist the strands together as tightly as possible.

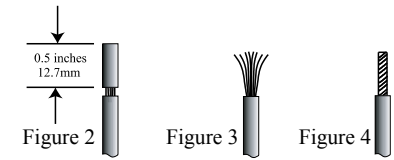

- Notes: 1. If desired, the twisted ends can be tinned with solder to keep the strands together.  
2. The prepared bare wire cable ends may be inserted into spade lug connectors.  
3. Banana plugs are for use in the United States and Canada only.*

### **Banana Plugs are for use in the United States and Canada only:**

4. Attach the previously prepared bare wire cable ends into the banana plugs and secure the connections. Refer to figure F.
5. Rotate the top of the Output Terminal Post clockwise until it is finger tight. Refer to figure G. Then using the McIntosh Wrench, rotate the top of the Output Terminal one quarter of a turn (90°). **Do not over tighten.** Refer to figure E.
6. Referring to figure H, connect the Loudspeaker hookup cables with banana plugs into the hole at the top of the terminal to the

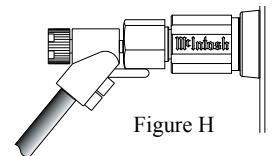
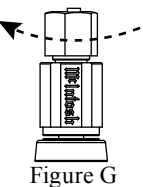
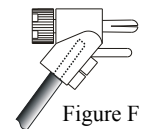

MC312 COM (Negative) Output Terminal and Positive Output Terminal indentified as 2Ω (ohms), 4Ω (ohms) or 8Ω (ohms) connection to match the impedance of the Loudspeaker, being careful to observe the correct polarities.

*Note: The illustration on separate sheet "McIA" is connections for 8Ω (ohms) Loudspeakers.*

If the Loudspeaker's impedance is in-between the available connections, use the nearest lower impedance connection. Refer to "General Information" Note 3 on page 2 for additional information.

**WARNING: Loudspeaker terminals are hazardous live and present a risk of electric shock. For additional instruction on making Loudspeaker Connections contact your McIntosh Dealer or McIntosh Technical Support.**

7. Connect the MC312 power cord to an active AC outlet.

**Spade Lug or Wire Connections:**

8. Connect the Loudspeaker hookup cables to the MC312 COM (Negative) Output Terminal and Positive Output Terminal indentified as 2Ω (ohms), 4Ω (ohms) or 8Ω (ohms) connection to match the impedance of the Loudspeaker, being careful to observe the correct polarities. Insert the spade lug connector or prepared section of the cable end into the terminal side access hole, and tighten the terminal cap until the cable is firmly clamped into the terminals so the lugs or wire cannot slip out. Refer to figures 7 and 8.

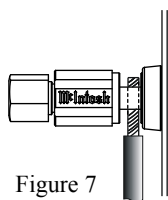

Figure 7

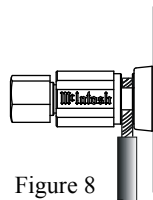

Figure 8

*Note: The illustration on separate sheet "McIA" is connections for 8Ω (ohms) Loudspeakers.*

If the Loudspeaker's impedance is in-between the available connections, use the nearest lower impedance connection. Refer to "General Information" Note 3 on page 2 for additional information.

**WARNING: Loudspeaker terminals are hazardous live and present a risk of electric shock. For additional instruction on making Loudspeaker Connections contact your McIntosh Dealer or McIntosh Technical Support.**

9. Connect the MC312 power cord to an active AC outlet.

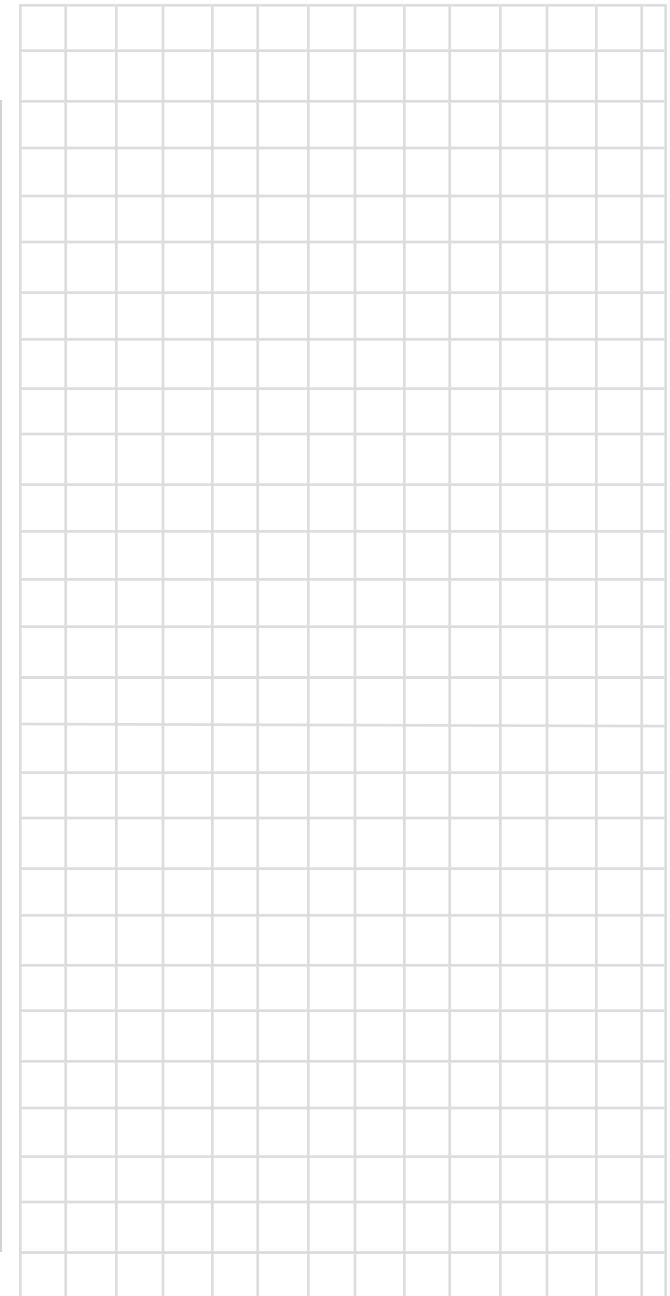



## Output Terminals

When connecting the Loudspeaker Hookup Cables to the MC312 Power Amplifier Output Terminals please follow the steps below:

1. Rotate the top of the Output Terminal Post counterclockwise until an opening appears. Refer to figures A and B.
2. Insert the Loudspeaker hookup cable into the Output Terminal Post opening or the cable spade lug around the center post of the Output Terminal. Refer to figure C.
3. Rotate the top of the Output Terminal Post clockwise until it is finger tight. Refer to figure D.
4. Place the supplied McIntosh Wrench over the top of the Output Terminal and rotate it one quarter of a turn (90°) to secure the Loudspeaker Cable Connection. **Do not over tighten.** Refer to figure E.

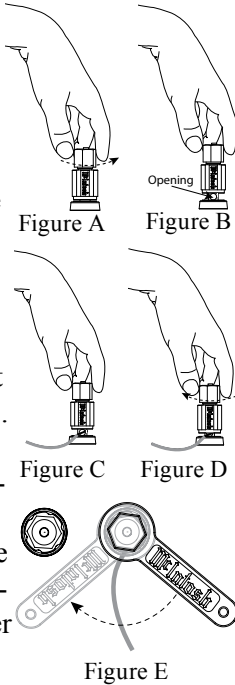

## How to Connect for Bi-Amp

**Caution: Do not connect the AC Power Cord to the MC312 Rear Panel until after the Loudspeaker Connections are made. Failure to observe this could result in Electric Shock.**

The connection instructions below, together with the MC312 Connection Diagram located on the separate folded sheet “Mc1B”, is an example of a typical audio system. Your system may vary from this, however the actual components would be connected in a similar manner. For additional information refer to “Connector and Cable Information” on page 3.

1. For Remote Power Control, connect a power control cable from the Audio Preamplifier or A/V Control Center Power Control Output 1 to the MC312 POWER CONTROL IN Amplifier One.

*Note: When a Power Control Cable is connected between the MC312 and Preamplifier (or A/V Control Center), the AUTO OFF Feature is bypassed. Refer to page 13.*

2. Connect a power control cable from Amplifier One Power Control OUTPUT 1 to the MC312 POWER CONTROL IN Amplifier Two.

*Note: When the MC312 (Power Amplifier 2) has Loudspeakers connected to it with a Power Control Input, then connect the MC312 Power Control Out 1 and Out 2 to the Loudspeakers.*

3. Connect XLR cables from the Balanced Output 1 (L&R) of an Audio Preamplifier or A/V Control Center to the MC312 Balanced INPUT (RIGHT and LEFT) on Amplifier One. Place the INPUT MODE Switch in the BALANCED Position.

*Note: An optional hookup is to use unbalanced cables and place the INPUT MODE Switch in the UNBALANCED Position.*

4. Connect XLR cables from the MC312 (Power Amplifier 1) Audio Balanced OUTPUT (LEFT and RIGHT) to the MC312 (Power Amplifier 2) Balanced INPUT (RIGHT and LEFT). Place the INPUT MODE Switch in the BALANCED Position.

This McIntosh MC312 Power Amplifier is designed for Loudspeakers with an impedance of 2 ohms, 4 ohms or 8 ohms. Connect a single Loudspeaker only to the Right and Left Output Terminals.

When connecting Loudspeakers to the MC312 it is very important to use cables of adequate size, so there is little to no power loss in the cables. The size is specified in Gauge Numbers or AWG (American Wire

Gauge). The smaller the Gauge number, the larger the wire size:

Loudspeaker Cable Distance vs Wire Gauge Guide			
Loudspeaker Impedance	25 feet (7.62 meters) or less	50 feet (15.24 meters) or less	100 feet (30.48 meters) or less
2 Ohms	12AWG	10AWG	8AWG
4 Ohms	14AWG	12AWG	10AWG
8 Ohms	16AWG	14AWG	12AWG

5. Prepare the Loudspeaker Hookup Cables for attachment to the MC312 Power Amplifiers:

### Bare wire cable ends:

Carefully remove sufficient insulation from the cable ends, refer to figures 2, 3 & 4. If the cable is stranded, carefully twist the strands together as tightly as possible.

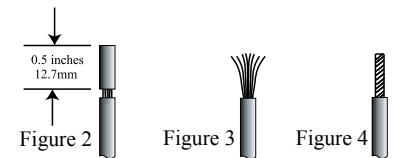

- Notes:*
1. If desired, the twisted ends can be tinned with solder to keep the strands together.
  2. The prepared bare wire cable ends may be inserted into spade lug connectors for use in outside the United States and Canada only.
  3. Banana plugs are for use in the United States and Canada only.

### **Banana Plugs are for use in the United States and Canada only:**

6. Attach the previously prepared bare wire cable ends into the banana plugs and secure the connections. Refer to figure F.

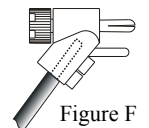

7. Rotate the top of the Output Terminal Post clockwise until it is finger tight. Refer to figure G. Then using the Mc-Intosh Wrench, rotate the top of the Output Terminal one quarter of a turn (90°). **Do not over tighten.** Refer to figure E on page 9.

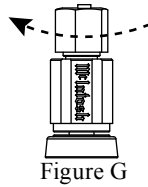

8. Referring to figure H, connect the Loudspeaker hookup cables with banana plugs into the hole at the top of the terminal to the MC312 COM (Negative) Output Terminal and Positive Output Terminal identified as 2Ω (ohms), 4Ω (ohms) or 8Ω (ohms) connection to match the impedance of the Loudspeaker, being careful to observe the correct polarities.

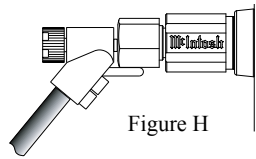

*Note: The illustration on separate sheet “Mc1B” is connections for 8Ω (ohms) Loudspeakers.*

If the Loudspeaker’s impedance is in-between the available connections, use the nearest lower impedance connection. Refer to “General Information” Note 3 on page 2 for additional information.

**WARNING: Loudspeaker terminals are hazardous live and present a risk of electric shock. For additional instruction on making Loudspeaker Connections contact your McIntosh Dealer or McIntosh Technical Support.**

9. Connect the MC312 power cord to an active AC outlet.

### Spade Lug or Wire Connections:

10. Connect the Loudspeaker hookup cables to the MC312 COM (Negative) (-) Output Terminal and Positive Output Terminal identified as 2Ω (ohms), 4Ω (ohms) or 8Ω (ohms) connection to match the

impedance of the Loudspeaker, being careful to observe the correct polarities. Insert the spade lug connector or prepared section of the cable end into the terminal side access hole, and tighten the terminal cap until the cable is firmly clamped into the terminals so the lugs or wire cannot slip out. Refer to figures 7 and 8.

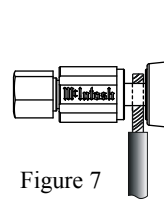

Figure 7

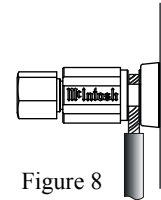

Figure 8

*Note: The illustration on separate sheet “Mc1B” is connections for 8Ω (ohms) Loudspeakers.*

If the Loudspeaker’s impedance is in-between the available connections, use the nearest lower impedance connection. Refer to “General Information” Note 3 on page 2 for additional information.

**WARNING: Loudspeaker terminals are hazardous live and present a risk of electric shock. For additional instruction on making Loudspeaker Connections contact your McIntosh Dealer or McIntosh Technical Support.**

11. Connect the MC312 power cord to an active AC outlet.







Meter indicates the Left Channel Output of the amplifier

LED indicates when the LEFT Channel Amplifier POWER GUARD circuit activates

Standby Power On Indicator

LED indicates when the RIGHT Channel Amplifier POWER GUARD circuit activates

Meter indicates the Right Channel Output of the amplifier

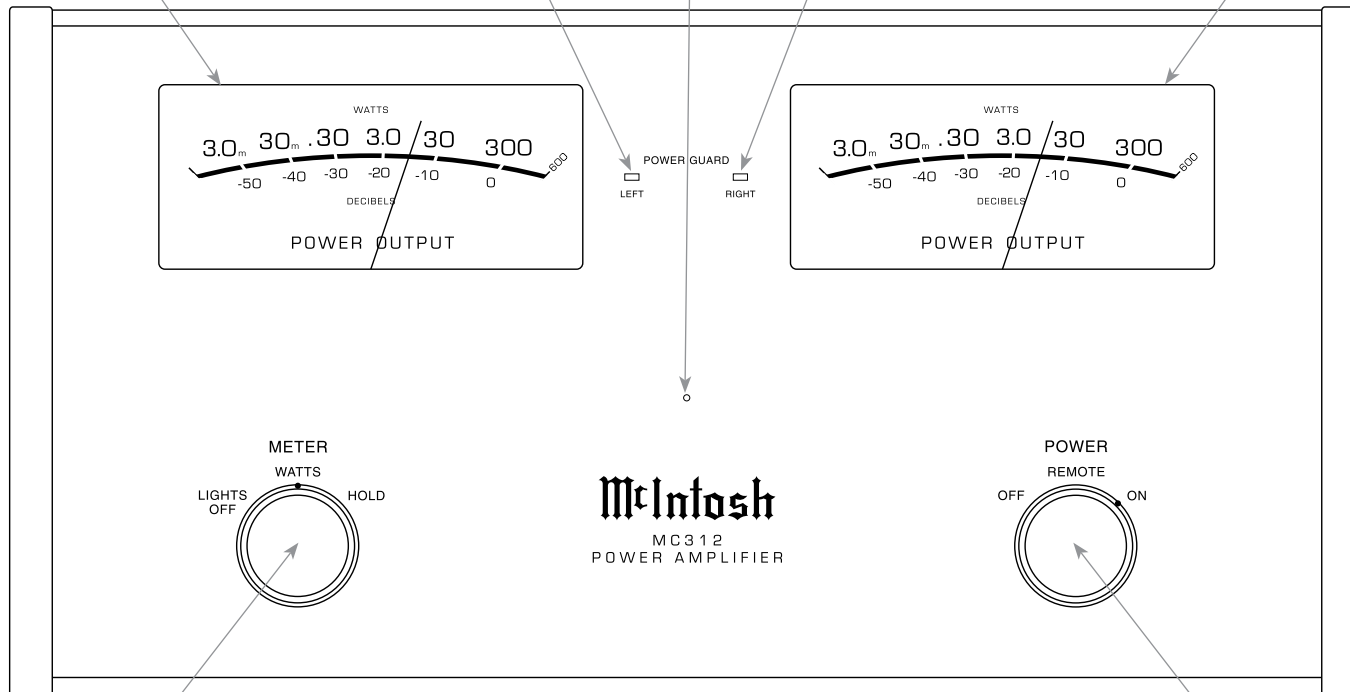

METER Switch selects the display modes of the Power Output Meter and Meter Illumination

POWER Switch Turns AC Power Off, Remote, AC Power On

## How to Operate

### Power On

To have the MC312 automatically turn On or Off when a Preamplifier or A/V Control Center turns On or Off, rotate the power switch to the Remote position. For manual operation, rotate the power switch to the On or Off position as desired. Refer to figure 9.

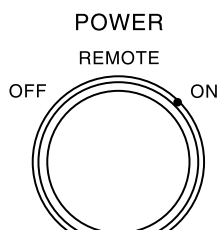

Figure 9

*Note: There must be a power control connection between the MC312 and the Audio Preamplifier (or A/V Control Center), in order for the remote power turn-on to function.*

### Meter Selection

Rotate the meter mode switch to select the meter operation mode you desire. Refer to figures 10 and 11.

Lights Off - Meter lights

are turned off and the meter will continue to indicate the power output.

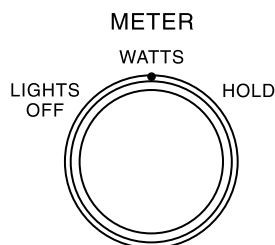

Figure 10

*Note: When Power Control Input of the MC312 is connected to an Audio Preamplifier or A/V Control Center with Remote Meter Illumination Control, the Meter Illumination will automatically be remotely controlled (On/Off) with the METER Switch set to the WATTS or HOLD position.*

Watts- The meters respond to all the musical information being produced by the amplifier. They indicate to an accuracy of at least 95% of the power output with only a single cycle of a 2000Hz tone burst.

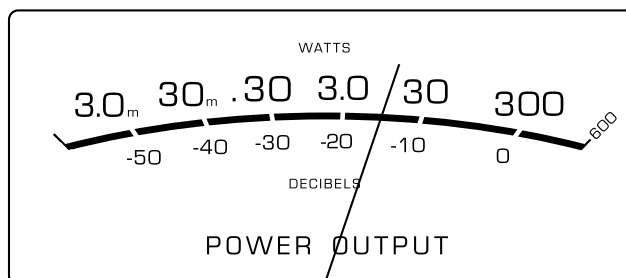

Figure 11

Hold - The meter pointer is locked to the highest power peak in a sequence of peaks. It is electronically held to this power level until a higher power peak passes through the amplifier. The meter pointer will then rise to the newer higher indication. If no further power peaks are reached, the meter pointer will very slowly return to its rest position or lower power level. The decay rate is approximately 6dB per minute.

*Note: The MC312 Power Output Meter indicates the actual power delivered to the loudspeakers by responding to the combination of current and voltage output.*

### Input Mode Switch

The Input Mode Switch, which is located on the Rear Panel of the MC312, allows selection of either the Balanced or Unbalanced Input. Refer to figure 12.

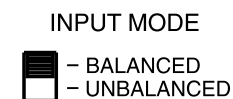

Figure 12

### Auto Off Switch

The MC312 incorporates Power Save Circuitry to automatically place the MC312 into the power saving Standby Mode approximately 30 minutes after there has been an absence of an audio input signal.

When there is a Power Control Connection between the MC312 and a Preamplifier with Power Save Circuitry, the AUTO OFF Switch is bypassed (located on the Rear Panel of the MC312). Refer to figure 13.

In the event there is no Power Control Connection and the Power Save Circuitry is activating inappropriately relative to your specific use of the MC312, place the AUTO OFF Switch in the DISABLE position.

*Note: If the Power Save Circuitry has switched Power to the MC312 OFF, place the POWER in the OFF Position and then in the ON position to reset the circuitry.*

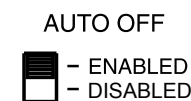

Figure 13



## Technical Description

McIntosh Laboratory, the company who introduced the world's first amplifier that could be called "High Fidelity", has done it again. The McIntosh engineering staff has created a power amplifier without compromise, using the most advanced McIntosh circuit design concepts.

The MC312 has a continuous average power output rating of 300 watts per channel, with a peak output current of 60 amperes, making it one of the most advanced amplifiers available today. The distortion limits for the MC312 are no more than 0.005% at rated power output for all frequencies from 20Hz to 20,000Hz. Typical performance at mid frequencies is less than 0.002%. The true distortion readings on the MC312 are so low, it takes special measuring techniques to make accurate readings. The MC312 can deliver the best possible performance from any type of high quality loudspeaker system. Refer to figure 14.

Creating an amplifier with this level of performance did not come easily. Many months of design, testing and measuring were required. Extensive controlled listening tests, the ultimate form of measuring, were made before the final design was accepted.

## Design Philosophy

The design philosophy incorporated in the MC312 involved several different techniques, all based on sound scientific logic. Every stage of voltage or current amplification must be as linear as possible prior to the use of negative feedback. McIntosh engineers know how to properly design negative feedback circuits so they contribute to the extremely low distortion performance expected from a McIntosh amplifier. The typical McIntosh owner would never accept the approximately 100 times higher distortion of many non-feedback designs. Refer to figure 15.

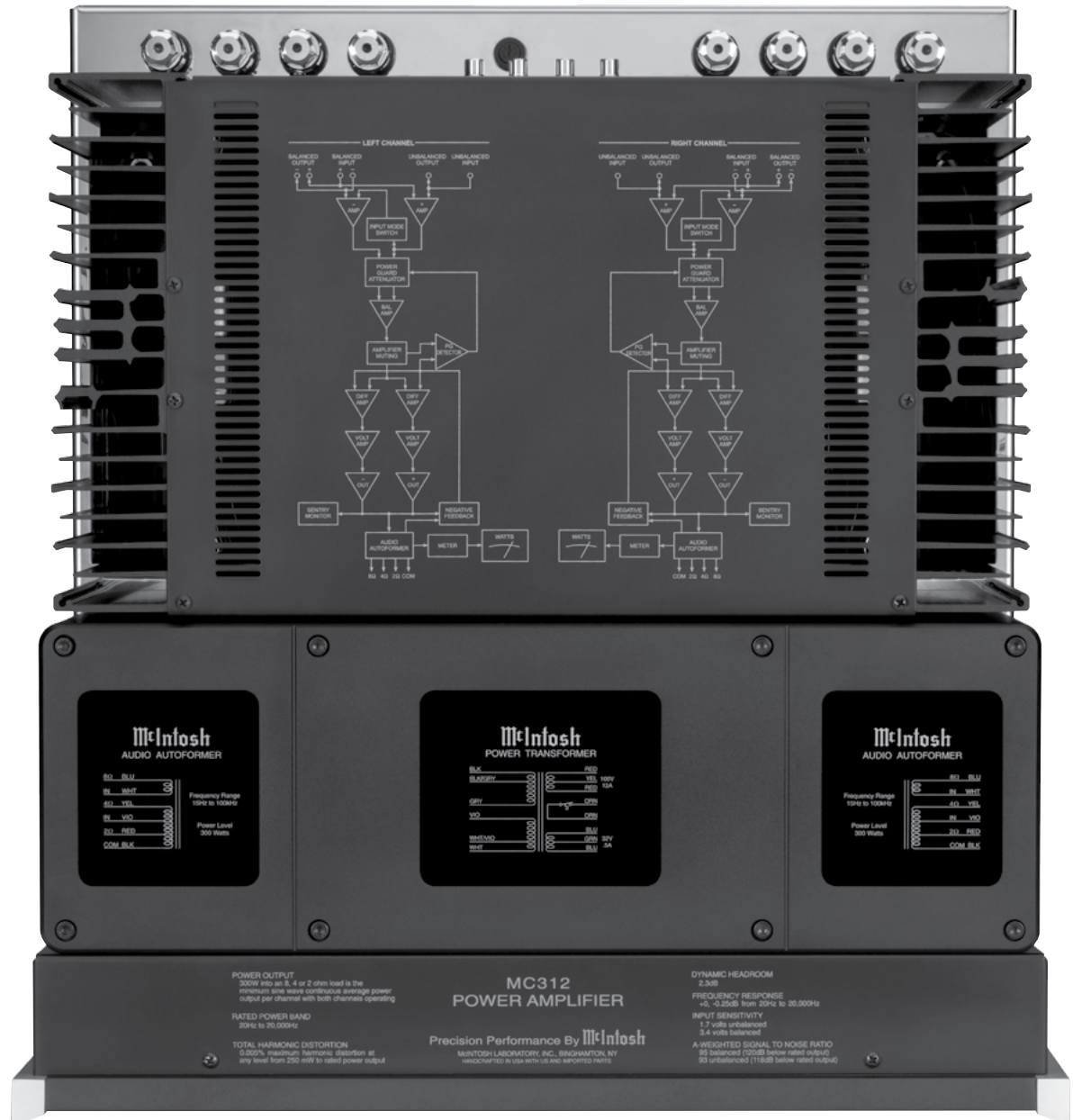
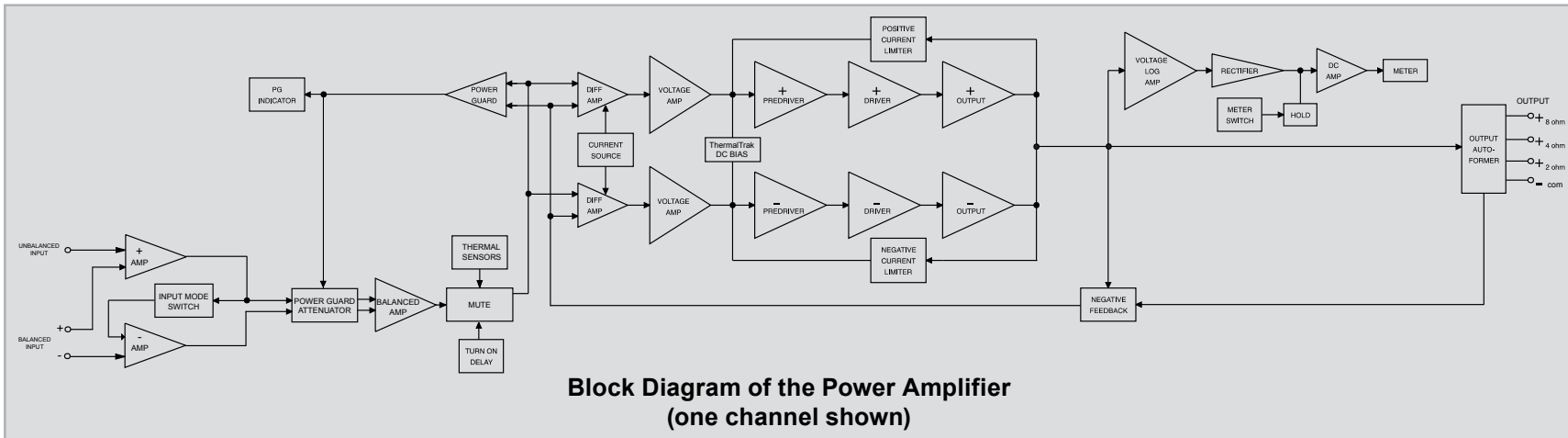

Figure 14



**Block Diagram of the Power Amplifier  
(one channel shown)**

Figure 15

All transistors are selected to have nearly constant current gain over the entire current range they must cover. Output transistors in particular, have matched uniform current gain, high current bandwidth product and large active region safe operating area. These Power Transistors are the very latest in semiconductor technology and incorporate a new design known as ThermalTrak™. Refer to figure 16. This allows for the instantaneous and accurate monitoring of the Power Transistor Temperature. The MC312 Power Output Circuitry has a specially designed bias circuit to take full advantage of the ThermalTrak™ Power Transistors and thus precisely controls the power amplifier operation over a wide range of music conditions with the benefits of lower distortion and cooler operation. Precision metal film resistors and low dielectric absorption film capacitors are used in all critical circuit locations.

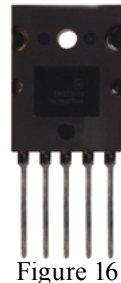

Figure 16

The output signals of the amplifier circuit is coupled together in the unique McIntosh MC312 Output Autoformer. It provides low distortion power transfer at frequencies from below 20Hz to well beyond 20,000Hz with optimum impedance points of two ohms, four ohms and eight ohms. The unequalled expertise of McIntosh in the design and manufacturing of autoformers is legendary in the high fidelity industry.

The high efficiency circuit design of the MC312 contributes to low operating temperatures. More than 1400 square inches of heat sink area keep the MC312 operating safely with convection cooling. No fans are needed. Refer to figure 17.

**Autoformers**

All solid state power amplifier output circuits work best into what is called an optimum load. This optimum load

may vary considerably from what a loudspeaker requires. In the case of more than one loudspeaker connected in parallel, the load to the power amplifier may drop to two ohms or even less. A power amplifier connected to a load that is lower than optimum, causes more output current to flow, which results in extra heat being generated in the power output stage.

This increase in temperature will result in a reduced life expectancy for the amplifier. The Autoformer creates an ideal match between the power amplifier output stage and the loudspeaker.

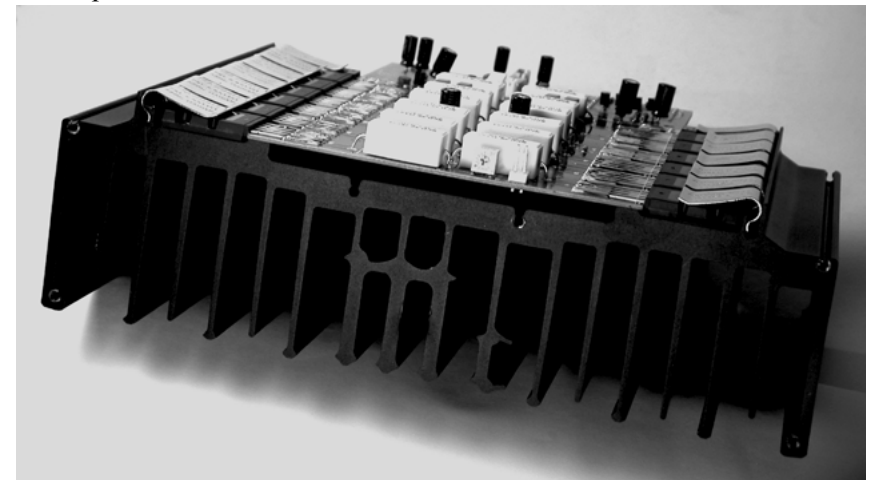

Figure 17

## Technical Description, con't

Refer to figure 18.

There is absolutely no performance limitation with an Autoformer. Its frequency response exceeds that of the output circuit itself, and extends well beyond the audible range. Its distortion level is so low it is virtually impossible to measure.

In the rare event of a power amplifier output circuit failure, the McIntosh Autoformer provides absolute protection from possible damage to your valuable loudspeakers. The unequaled expertise of McIntosh in the design and manufacturing of Autoformers is legendary in the high fidelity industry. McIntosh engineers know how to do it right.



Figure 18

### Power Output Meter

The McIntosh MC312 has large Output Watt Meters that respond 95% full scale to a single cycle tone burst at 2kHz. Refer to figure 17. The Voltage Output is electronically measured and fed to a special circuit that accelerates the pointer movement in the upward direction. Refer to figure 25 on the next page. When the pointer reaches its peak it pauses only long enough for the human eye to perceive its position, then drops.

It is almost 10 times faster than a professional VU meter.

A front panel switch is provided to change the meter to the Watts Hold Mode of operation. This allows fast upward movement of the pointer but greatly increases Hold Time at the peak of its travel. The highest power output of the source material is thus recorded.

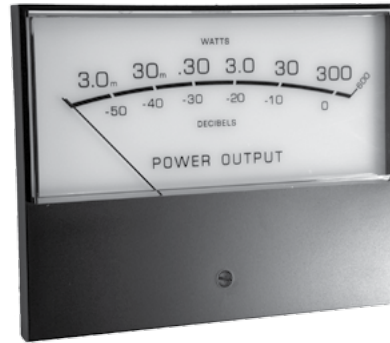

Figure 19

### Protection Circuits

The MC312 incorporates the McIntosh Sentry Monitor Output Transistor Protection Circuit. Refer to Figure 18. There is absolutely no compromise in sonic performance with this circuit, and it ensures safe operation of the amplifier under even the most extreme operating conditions. The different types of protection circuits incorporated in the MC312 insure a long and safe operating life. This is just one of the many characteristics of McIntosh Power Amplifiers that make them world famous.

The MC312 also includes the unique patented McIntosh Power Guard circuit. Power Guard eliminates

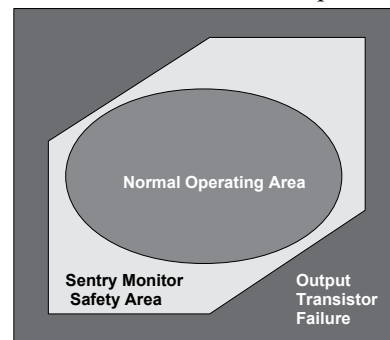

Figure 20

the possibility of ever overdriving the amplifier into clipping. Refer to figures 19, 20 and 21. An overdriven amplifier can produce both audible and inaudible distortion levels exceeding 40%. The audible distortion is unpleasant to hear, but the inaudible ultrasonic distortion is also undesirable, since it can damage valuable loudspeaker system tweeters. You will never experience the harsh and damaging distortion due to clipping.

The Power Guard circuit is a waveform comparator, monitoring both the input and output waveforms.

Under normal operating conditions, there are no differences between the shape of these waveforms. If an amplifier channel is overdriven, there will be a difference between the two signal waveforms. When the difference exceeds 0.3%, the Power Guard activates the PG light and a dynamic electronic attenuator at the amplifier input reduces the input volume just enough to prevent any further increase in distortion. The Power Guard circuit acts so fast that there are absolutely no audible side effects and the sonic purity of the music reproduction is

Input Test Signal  
(14kHz & 15kHz)

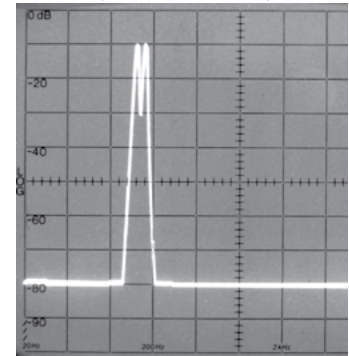

Figure 21

Without Power Guard

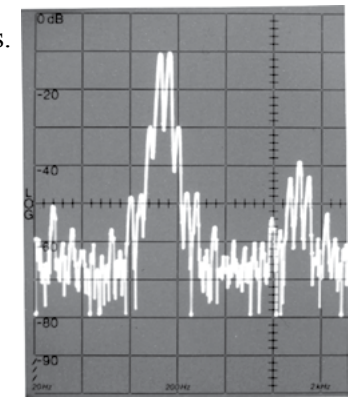

Figure 22



perfectly preserved. The MC312 Power Amplifier with Power Guard is not limited to just the rated power output, but will actually produce distortion free output well above its rated power due to the McIntosh philosophy of conservative design.

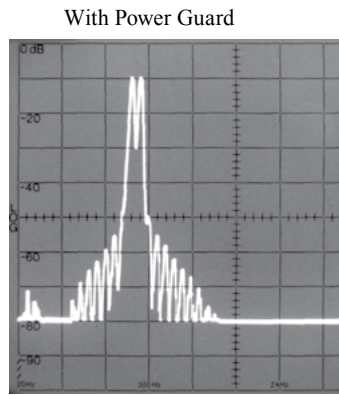

Figure 23

**Power Supply Circuits**

To compliment the design of the MC312 Power Amplifier Circuitry, there is a high current high voltage power supply for both channels. Refer to figures 24 and 27. The very large Power Transformer can supply over 13 amps of continuous current. Refer to figure 25 (golf ball is for size comparison). It is enclosed in the legendary McIntosh Potted Enclosures and weighs 28 lbs. The two super size main filter capacitors can store over 300 Joules of energy

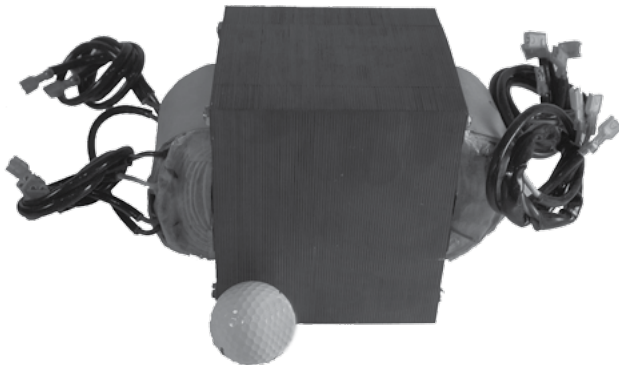

Figure 25

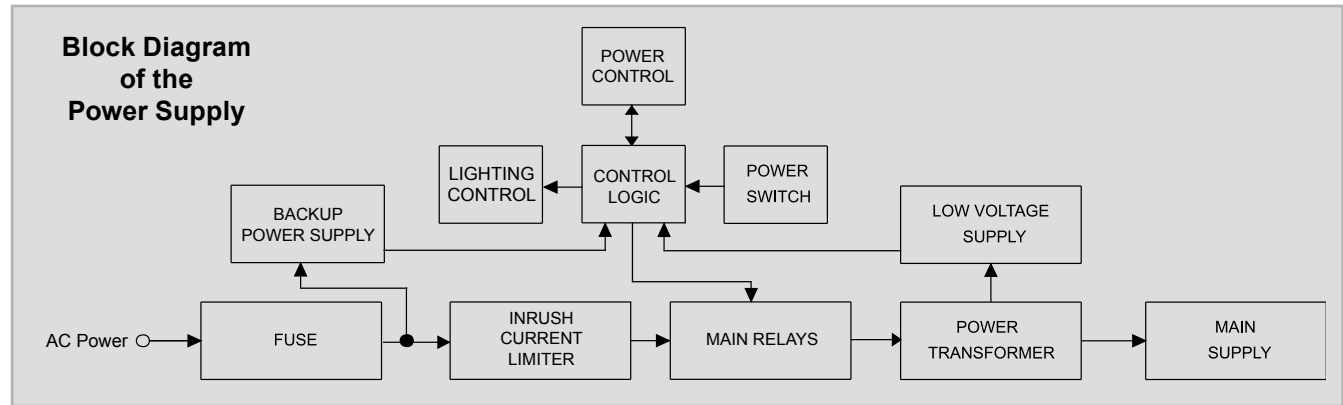

Figure 24

for both amplifier channels, necessary for the wide dynamic range that “Digital Audio” demands. Refer to figure 26.

The power amplifier draws high current from the AC power line. Therefore, it is important that they plug directly into the wall outlet.

Also, most owners desire one power switch for the whole audio system. The MC312 is equipped with a circuit that provides remote Power Control from a McIntosh A/V Control Center. Refer to figure 27.



Figure 26

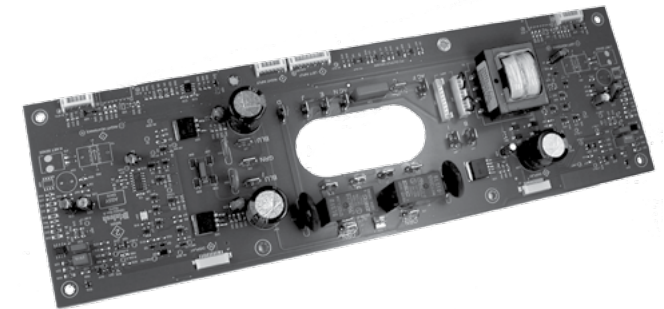

Figure 27

When the A/V Control Center is switched On, a (+5V) signal operates the power relay in the MC312. The MC312 also has two remote Power Control Out Jacks. The Power Control signal from these jacks is delayed by a fraction of a second so that the turn on power surge of the next power amplifier occurs at a later time. This helps prevent power circuit overload that could trip circuit breakers or blow fuses, a very important feature in a high power Home Systems employing multiple MC312 Power Amplifiers.



## Specifications

### Power Output

Minimum sine wave continuous average power output per channel, with both channels operating is:

300 watts into 2 ohm load

300 watts into 4 ohm load

300 watts into 8 ohm load

### Output Load Impedance

2, 4 or 8 ohms

### Rated Power Band

20Hz to 20,000Hz

### Total Harmonic Distortion

0.005% maximum harmonic distortion at any power level from 250 milliwatts to rated power, 20Hz to 20,000Hz

### Dynamic Headroom

2.3dB

### Frequency Response

+0, -0.25dB from 20Hz to 20,000Hz

+0, -3.0dB from 10Hz to 100,000Hz

### Input Sensitivity (for rated output)

3.4 Volts Balanced

1.7 Volts Unbalanced

### Signal To Noise Ratio (A-Weighted)

95dB Balanced (120dB below rated output)

93dB Unbalanced (118dB below rated output)

### Intermodulation Distortion

0.005% maximum, if the instantaneous peak power output does not exceed twice the rated power output for any combination of frequencies from 20Hz to 20,000Hz.

### Wide Band Damping Factor

Greater than 40

### Input Impedance

22,000 ohms Balanced

22,000 ohms Unbalanced

### Voltage Gain

29dB, 8 Ohms

26dB, 4 Ohms

23dB, 2 Ohms

### Power Guard

Less than 2% Total Harmonic Distortion with up to a 14dB overdrive signal

### Power Control Input

5-15VDC, less than 1mA

### Power Control Output 1 and 2

12VDC, 50mA maximum total

Output is delayed 0.2 seconds from turn On

### Power Requirements

**Field AC Voltage conversion of the MC312 is not possible. The MC312 is factory configured for one of the following AC Voltages:**

100V ~ 50/60Hz at 8 Amps

110V ~ 50/60Hz at 6.6 Amps

120V ~ 50/60Hz at 6.6 Amps

127V ~ 50/60Hz at 6.6 Amps

220V ~ 50/60Hz at 3.6 Amps

230V ~ 50/60Hz at 3.3 Amps

240V ~ 50/60Hz at 3.3 Amps

Standby: less than 0.5 watt

*Note: Refer to the rear panel of the MC312 for the correct voltage.*

### Overall Dimensions

Width is 17-1/2 inches (44.45cm)

Height is 9-7/16 inches (23.97cm) including feet

Depth is 22 inches (55.88cm) including the Front Panel, Knobs and Cables

### Weight

105 pounds (47.63 kg) net, 138 pounds (62.59 kg) in shipping carton

### Shipping Carton Dimensions

Width is 29-1/2 inches (74.93cm)

Depth is 29 inches (73.66cm)

Height is 17 inches (43.18cm)

**Packing Instructions**

In the event it is necessary to repack the equipment for shipment, the equipment must be packed exactly as shown below. It is very important that the four plastic feet are attached to the bottom of the equipment. Four 1/4 - 20x2-1/4 inch screws and washers must be used to fasten the unit securely to the bottom pad and wood skid. This will ensure the proper equipment location on the bottom pad. Failure to do this will result in shipping damage.

Use the original shipping carton and interior parts only if they are all in good serviceable condition. If a shipping carton or any of the interior part(s) are needed, please call or write Customer Service Department of McIntosh Laboratory. Refer to page 2. Please see the Part List for the correct part numbers.

Quantity	Part Number	Description
1	034052	Shipping carton top
1	034051	Shipping carton bottom
2	034054	Foam Pad (top and bottom)
2	034186	Foam Pad (front and rear)
2	034187	Foam Pad (sides)
1	034136	Inner carton top
1	034137	Inner carton bottom
1	034188	Foam Pad (inner carton)
1	034479	Shipping skid
4	401212	1/4 - 20x2-1/4 cap screw
4	104058	Flat washer

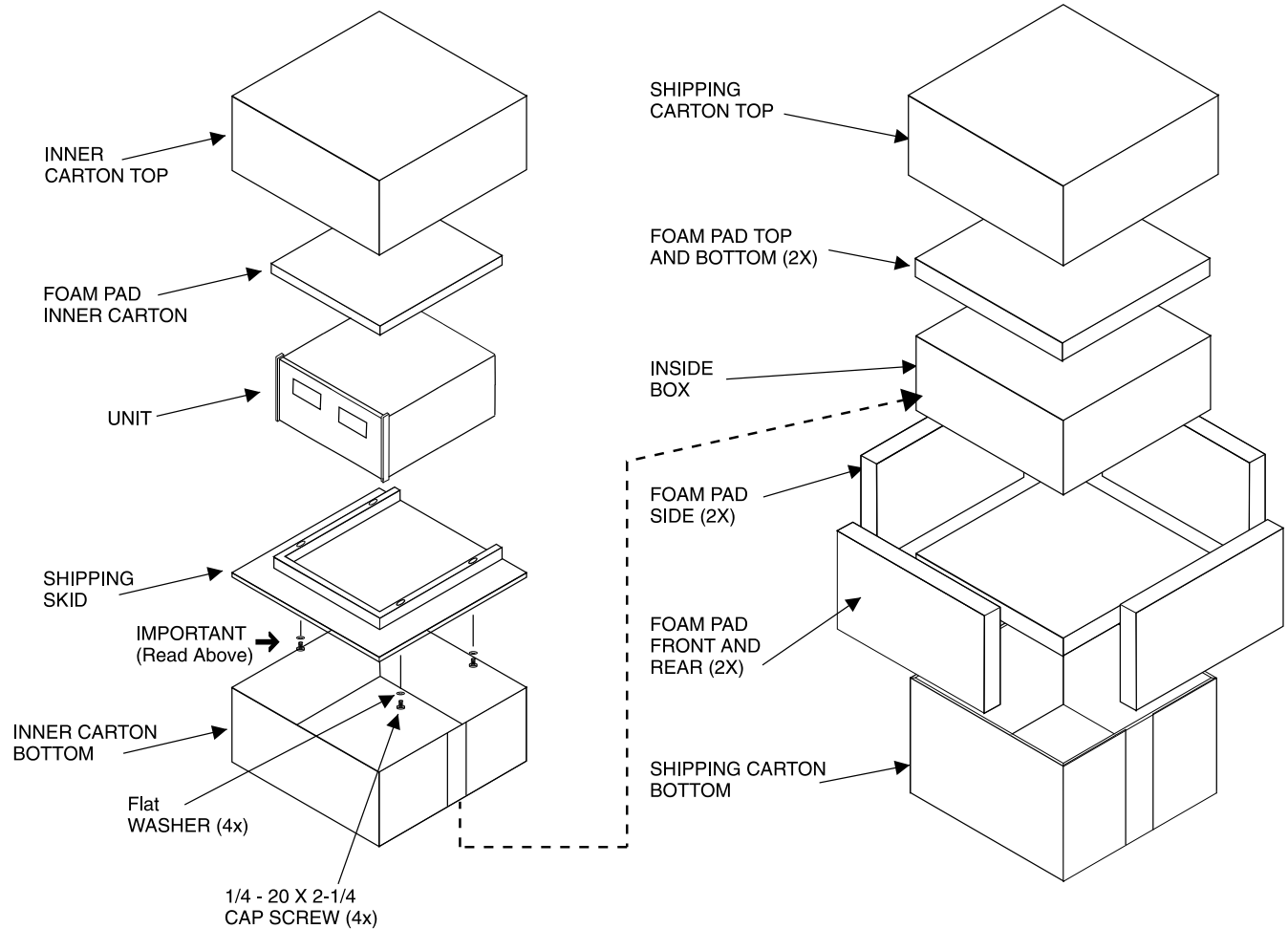



McIntosh Laboratory, Inc.  
2 Chambers Street  
Binghamton, NY 13903  
[www.mcintoshlabs.com](http://www.mcintoshlabs.com)

The continuous improvement of its products is the policy of McIntosh Laboratory Incorporated who reserve the right to improve design without notice.  
Printed in the U.S.A.