

McIntosh

Owner's Manual

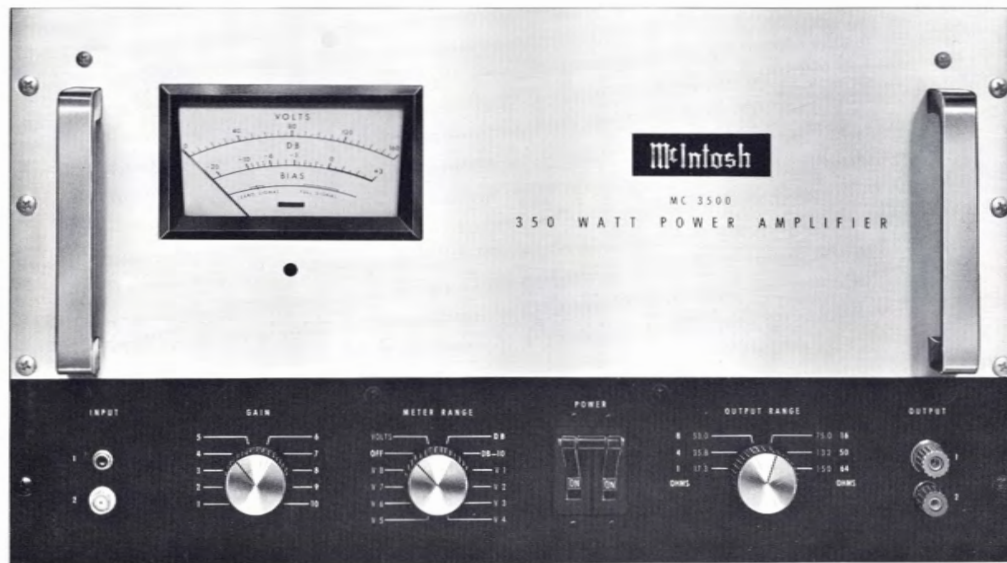

McIntosh
MC 3500

POWER AMPLIFIER

MC 3500

PRICE \$1.25

Dear Friend:

Thank you for selecting the new McIntosh MC 3500. Your discriminating choice places you in a very happy family of McIntosh owners.

The true world of sound in all its fullness and beauty is now yours and you will have many thousands of hours of enjoyment through this superb high-powered instrument.

This is your owner's manual prepared to tell you everything you need to know about your new MC 3500.

The more you know about installing and operating your MC 3500 the more enjoyment you'll get from it.

So read the manual carefully and keep it where it can be consulted from time to time.

McIntosh Laboratory Inc.
Binghamton, N. Y.

CONTENTS

GENERAL DESCRIPTION	2
TECHNICAL INFORMATION	2-3
SPECIAL FEATURES	3
QUICK FACTS	4
FRONT PANEL INFORMATION	5
CONNECTIONS & ADJUSTMENTS	6
BLOCK DIAGRAM	7
PERFORMANCE CHARTS	8
TYPICAL HOOKUP	9
SPECIFICATIONS	11
GUARANTEE	12

NOTE: For QUICK FACTS on the setup and operation of your MC 3500 turn to page 4.

McIntosh
MC 3500

POWER AMPLIFIER

MC 3500

McIntosh

GENERAL DESCRIPTION

The McIntosh MC 3500 is a high power amplifier for use in high quality music systems, sound reinforcement and other low distortion, high power applications. The outstanding characteristic of this amplifier is the extremely low distortion at all power levels up to 350 watts from 20 to 20 kHz. To achieve this performance the amplifier uses tubes in the audio circuits and solid state devices in the power supply as rectifiers and regulators. Solid state devices are also used in the meter circuits.

Input jacks and output terminals are located on the front panel and on the rear of the chassis. An input gain control can be used to set the right level of signal input. An output control provides for six different levels of load impedance or output voltage.

A front panel meter on the MC 3500 can be used to indicate one of three operating conditions. The meter range switch selects the following:

- 1 The correct tolerance of cathode current is indicated for tubes V1 through V8.
- 2 The voltage at the output terminals is indicated when the selector is turned to "Volts".
- 3 The short interval peak power output is indicated in decibels relative to 350 watts.

***The MC 3500 is a powerful
350 watt power amplifier!***

TECHNICAL DESCRIPTION

The MC 3500 is an outstanding example of the flexibility and utility of the basic McIntosh amplifier circuit patents. The McIntosh circuit was developed in 1947 at a time when high power, high efficiency and low distortion were impossible. A completely new engineering approach was used and the result was the first commercial power amplifier capable of 50 watts of power from 20 to 20 kHz at less than 1% distortion over this entire frequency range. The MC 3500 is another advance in McIntosh technology applied to circuits and transformers.

The MC 3500 uses an advanced form of the basic patented McIntosh unity coupled output circuit and transformer. This arrangement loads the output tubes equally in both the anode and cathode circuits. It is this combination of McIntosh unity coupled circuit and transformer which eliminates output stage distortion due to quasi-transients found in conventional circuits.

1. The MC 3500 output transformer uses a Pentafilar winding arrangement. The primary has 5 different filar windings. One of the windings is used in the cathode circuit of the output tubes. A second winding is used in the plate circuit of the output tubes. A third and fourth winding are used to properly connect the bias and screen grid voltages to the output and driver stages. The fifth winding supplies the feedback signal for two negative feedback loops. In this UNITY COUPLED feedback, one loop is the push-pull coupling to the balanced driver stage. The other, the main feedback loop, couples the feedback winding to the input differential amplifier. The PENTAFILAR windings are all wound on the transformer at the same time. This winding technique, developed and perfected by McIntosh, reduces leakage inductance by extremely tight coupling.
2. A greater amount of negative feedback can be obtained in an amplifier using primary feedback. The stability of the amplifier is not

SPECIAL FEATURES

affected. If the feedback winding is wound filarily with the primary and has the same number of turns, the feedback winding will have the same phase and voltage as the primary windings for frequencies up to 500 kHz. As such, it is UNITY COUPLED with the primary.

3. By using UNITY COUPLED negative feedback, it is possible to obtain up to 40 dB of feedback with very good stability and extremely low non-linear distortion. It is relatively easy to maintain a flat frequency response with very low phase shift in the electronic circuits of an amplifier prior to the output transformer. The high quality performance is now delivered to the output load with the use of the UNITY COUPLED PENTAFILAR McIntosh output transformer.
4. To achieve flat frequency response well beyond 20 kHz, very close coupling is required between the primary and secondary windings in the output transformer. McIntosh accomplishes this by dividing the PENTAFILAR primary into 10 different winding sections. The secondary is divided into 8 different winding sections. These winding sections are then interleaved. This expensive and difficult winding method provides optimum coupling and holds the shunt capacity to a minimum.

Magnetic circuit protectors have been provided in the MC 3500. In the event of severe overload or extreme overdriving of the output tubes, these protectors turn off the input power to the amplifier. When the condition is corrected the amplifier can be returned to normal operation by re-setting the on-off switch.

To ensure long life and trouble free operation a low noise maintenance-free fan has been built into the MC 3500. The fan cools the output stages and provides cooler operation of the entire amplifier. In the event that air circulation for the fan is cut off, or if for any reason the temperature should rise above a safe limit, a thermal protector turns off the AC power. When the temperature has returned to a safe operating level, the amplifier can be returned to normal operation by turning on the power switch.

There are a number of power supplies used in the MC 3500, all of which use solid state rectifiers. The output tube screen grid supply is specially regulated and electronically filtered.

McIntosh Laboratory has developed a unique and useful meter circuit that overcomes the problems inherent in the ballistics of a meter. With the use of the McIntosh Dynamic Peak Locking Meter circuit short interval power can be read to an accuracy of 98% of the true value.

See details under METER RANGE switch in "FRONT PANEL INFORMATION," page 5.



QUICK FACTS ON OPERATING THE MC 3500

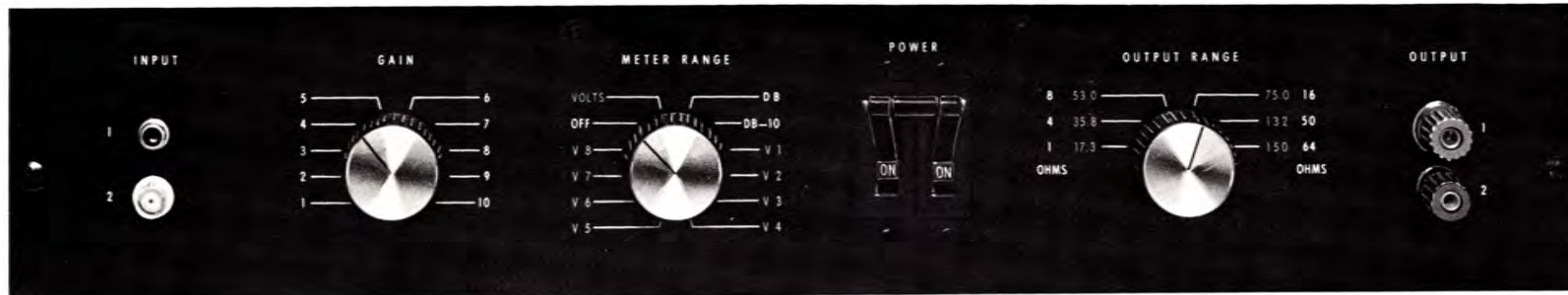

Be sure the power switch is off (down).

1. Put "GAIN" control at minimum (1).
2. Connect audio input to source of signal either to the front terminals or back, but **not both**.
Be sure ground connections are secure.
3. Connect the output load (speakers or other devices) to the output terminals either on front or back, but **not both**.
4. Set "OUTPUT RANGE" switch to proper impedance for the load used. Never change the position of the output range switch when the amplifier is in operation.
5. Set "METER RANGE" switch to V1 position.

6. Insert AC plug into 120V AC power source.
(Do not put the power plug for this amplifier into any other McIntosh pre-amplifier, power amplifier or tuner receptacle as these do not have sufficient power handling capacity.)

Double check above procedure before turning on power.

7. Turn on "POWER" switch.
8. With "GAIN" control still at minimum, check V1 through V8 cathodes by switching "METER RANGE" switch to the successive indicated positions and noting meter reading on lower scale. If each reads within the indicated area you are ready to use the amplifier.

NOTE: "METER RANGE" switch may be set to "VOLTS," "DB" or "DB-10" positions as desired.

9. Advance volume control on the MC 3500 gradually until measurable or audible signal is heard and adjust to suit application.

FRONT PANEL INFORMATION

INPUT

Two sets of input connections have been provided. One set is on the right side of the back panel at the rear of the unit. The other set is located on the left side of the front panel. The two sets of connectors are connected in parallel. There are two types of input connectors in each set. One is the RCA phono type; the other is BNC connector.

The LOW FREQUENCY ROLL-OFF switch is located on the back panel of the MC 3500. In the LOW FREQUENCY ROLL-OFF position, the response is rolled off below 5 Hz. In the normal position the response is flat.

GAIN

The input sensitivity of the MC 3500 is 1.1 volts, for 350 watts output. The input impedance is 200,000 ohms. A gain control permits the use of input signals up to 30 volts without overload.

METER RANGE

The METER RANGE switch has 12 positions. Eight are used to monitor the cathode current in each of the output tubes. Two of the positions are used to monitor output power levels. One of the positions is used to monitor the AC output voltage delivered by the amplifier.

In this position the meter is connected as an average reading voltmeter calibrated in RMS volts. The color of the markings for each switch position corresponds to the color of the scales on the meter face. The last position turns the meter off.

POWER

The POWER switch (and circuit breaker) turns the MC 3500 on in the up position and off in the down position.

OUTPUT RANGE

The OUTPUT RANGE switch has six positions. The switch is used to connect the proper output transformer impedance or voltage windings to the output connectors. Each position is marked both in impedance for loudspeakers and voltage for constant voltage distribution systems.

OUTPUT

Two sets of output connectors have been provided. One set is located on the right side of the front panel. The other set is located near the center of the back panel. These two sets of output connectors are wired in parallel.



Meticulous attention to detail, exacting performance from advanced design and long trouble-free life have always characterized McIntosh instruments. The MC 3500 is a new step in high powered amplifiers that enhances the McIntosh engineering reputation.

CONNECTIONS AND ADJUSTMENTS

CONNECTING THE MC 3500

INPUT:

Connect the signal source to either type connector on either the back panel or front panel. Any signal source with an output of from 1.1 to 30 volts will drive the MC 3500 to full output.

LOUDSPEAKER CONNECTORS:

Connect the loudspeaker leads to the barrier strip on the back panel or to the output connectors on the front panel.

ADJUSTMENTS

OUTPUT RANGE

Set the OUTPUT RANGE switch for the impedance that matches the loudspeaker.

METER RANGE

Set the METER RANGE switch to off.

GAIN

Turn the GAIN control totally counterclockwise to the minimum position.

POWER

Turn the POWER switch to the ON position.

CATHODE VOLTAGE CHECK

After a warm-up period of three minutes check the cathode current of each output stage.

Turn the METER RANGE switch to the V1 (Green) position. The meter should show a reading in the marked area on the bias scale. Repeat this procedure for each output stage by reading the meter in each of the 8 METER RANGE switch V positions.

ADJUSTING CATHODE VOLTAGE

In the event the meter indicates differently than that recommended, it may be necessary to adjust bias for the output tubes. On the bottom cover of the MC 3500 are eight holes marked BIAS ADJ. Each hole is marked with the V number of the corresponding output tube. Adjust the control that corresponds to the position set on the METER RANGE switch.

IMPORTANT: USE AN INSULATED SCREWDRIVER TO MAKE THESE ADJUSTMENTS.

To adjust the cathode voltage, slowly rotate the control with the insulated screwdriver. Counterclockwise rotation decreases and clockwise increases. After making any adjustments check the reading on all other V positions of the METER RANGE switch. THESE ADJUSTMENTS ARE MADE WITH **NO** SIGNAL INPUT TO THE AMPLIFIER.

MOUNTING

The MC 3500 can be mounted in the conventional manner in a standard 19" rack. The panel requires 10½" of panel space. Be sure to allow 2" in front of the panel for the knobs. The depth required is 17" back of panel. Be certain to provide adequate ventilation.

TYPICAL HOOK UP

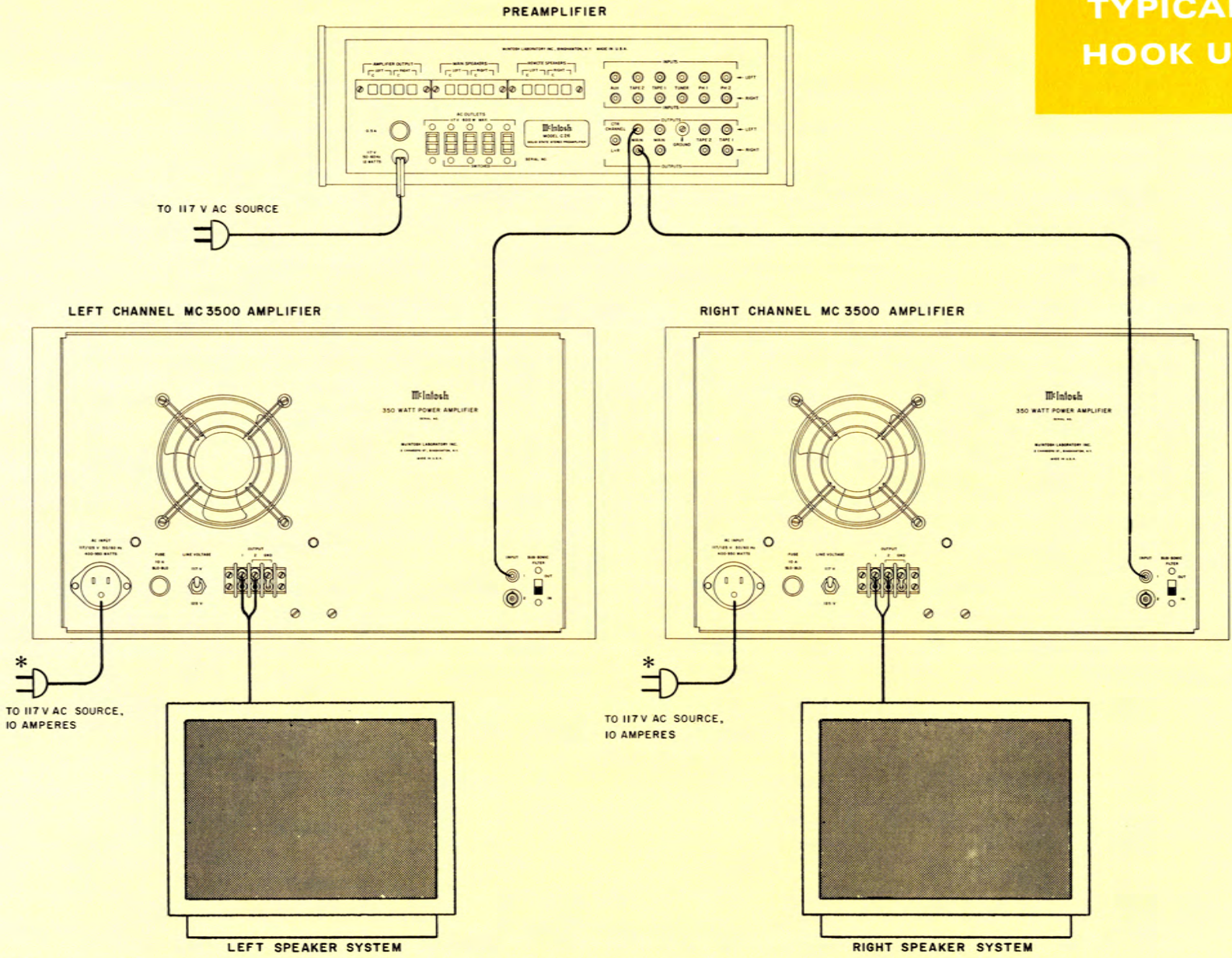

* DO NOT CONNECT MC 3500 LINE CORD INTO PREAMPLIFIER AC OUTLETS. IF REMOTE MC 3500 POWER CONTROL IS NEEDED USE AN EXTERNAL RELAY.

TYPICAL PERFORMANCE DATA

POWER OUTPUT VS FREQUENCY

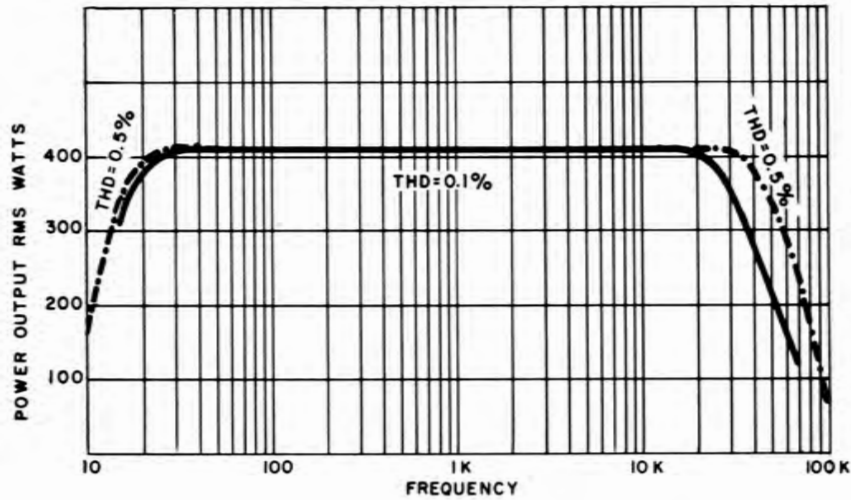

HARMONIC DISTORTION VS POWER OUTPUT

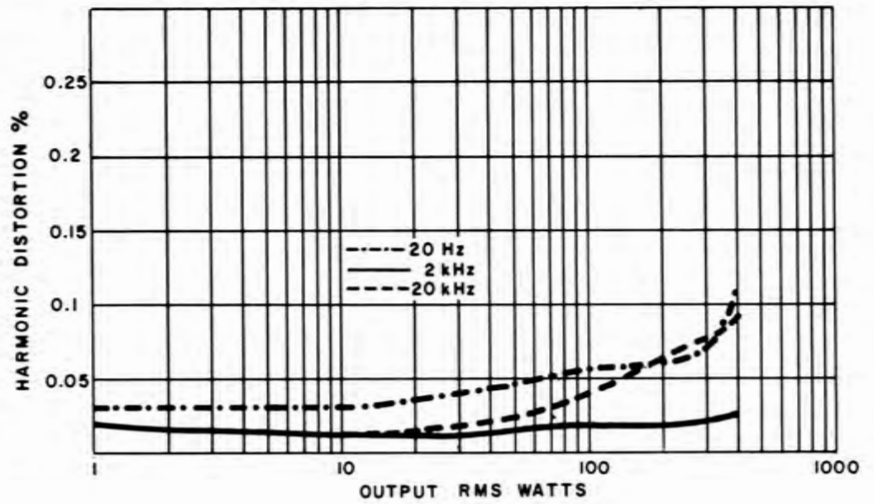

MAXIMUM OUTPUT VS LOAD POWER FACTOR

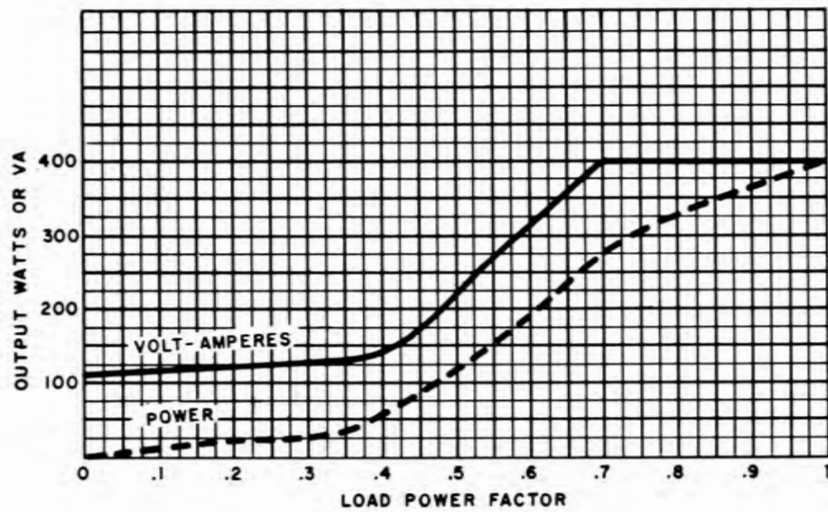

INTERMODULATION DISTORTION VS POWER OUTPUT

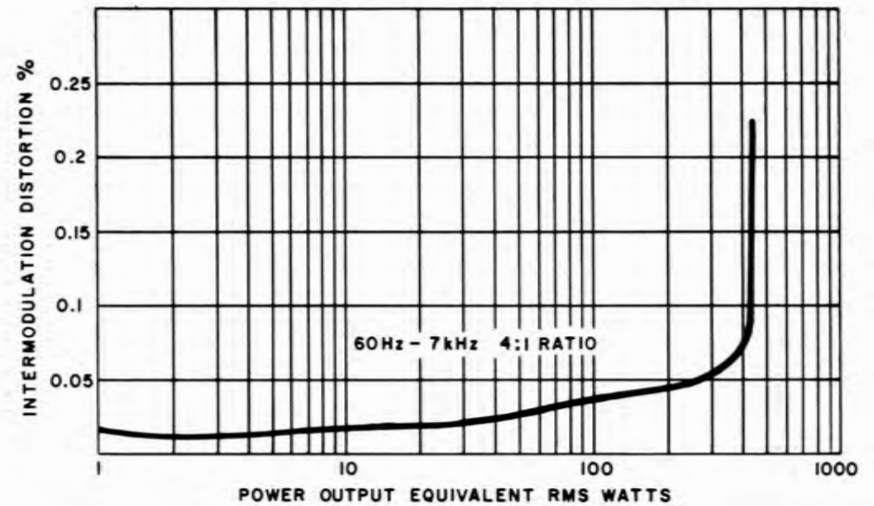

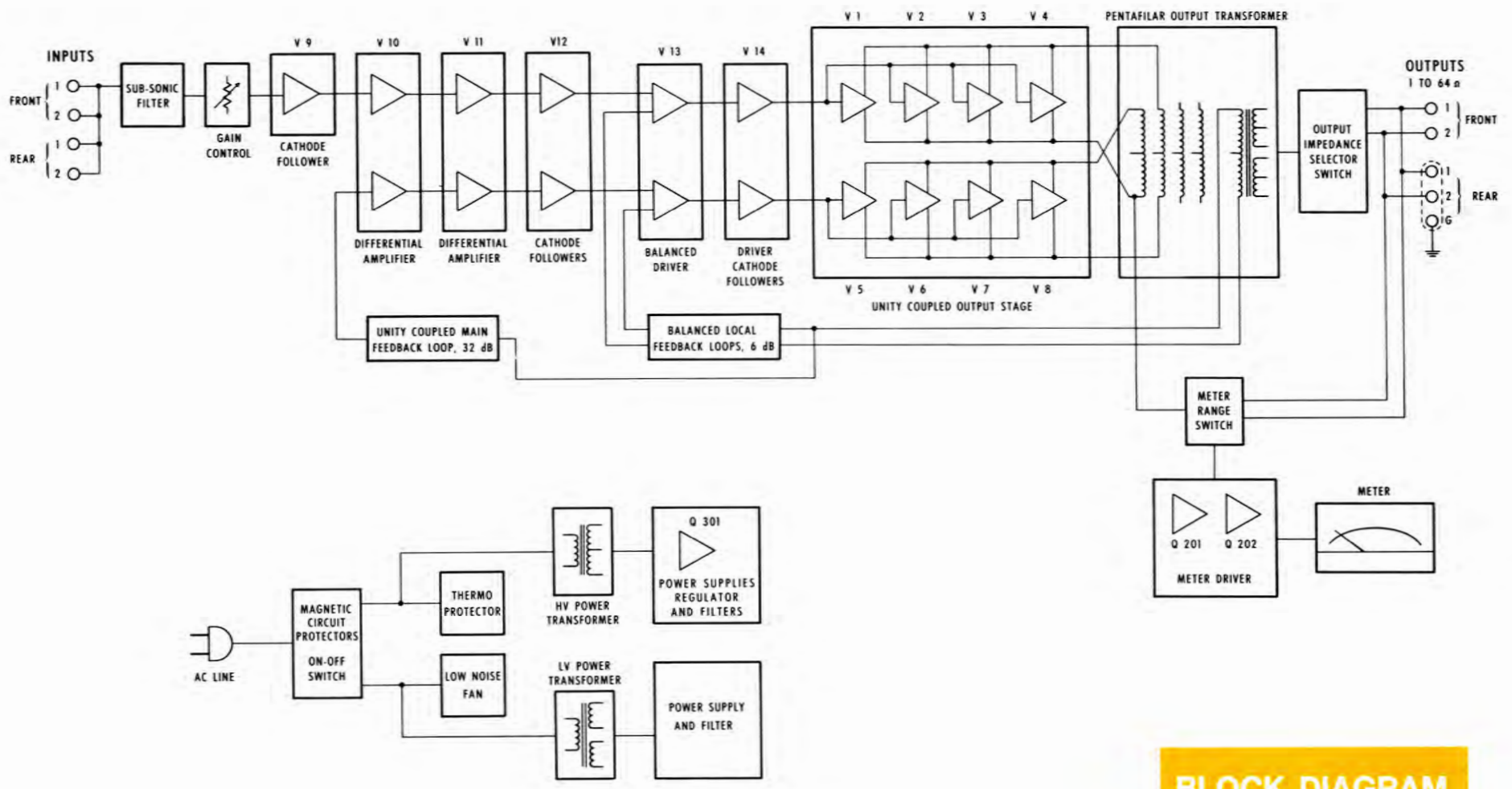

BLOCK DIAGRAM

HEAR ALL THERE IS TO HEAR WITH THE MC 3500



SPECIFICATIONS

ELECTRICAL SPECIFICATIONS

POWER OUTPUT:

350 watts continuous

HARMONIC DISTORTION:

Less than 0.15% at 350 watts output or less 20 Hz through 20 kHz

INTERMODULATION DISTORTION:

Less than 0.15% for any combination of frequencies from 20 Hz through 20 kHz if instantaneous peak power is below twice rated power.

FREQUENCY RANGE:

AT RATED OUTPUT:

+0, -0.5 dB, 20 Hz through 20 kHz

AT REDUCED OUTPUT:

+0, -3.0 dB at 1 watt output, 1 Hz through 70 kHz

NOISE AND HUM:

95 dB or more below rated output (unweighted)

OUTPUT IMPEDANCE:

1 ohm, 4 ohms, 8 ohms, 16 ohms, 50 ohms, and 64 ohms. May be operated isolated from ground. (1 ohm output is rated to 300 watts, the 4 ohm output is rated to 320 watts.)

OUTPUT VOLTAGES:

17.3 volts, 35.8 volts, 53 volts, 75 volts, 132 volts, 150 volts. May be operated isolated from ground. The 75 volt output is used to power 70.7 volt sound distribution lines. The 150 volt output is used to power 141.4 volt distribution lines. The 132 volt output is used to provide 117 volt for laboratory or industrial applications. (17.3 volt output is rated to 300 watts, the 35.8 volt output is rated to 320 watts.)

INTERNAL IMPEDANCE:

About 5% of rated load impedance. The 1 ohm and 17.3 volt output is rated about .1 ohm.

INPUT:

Input Impedance—200,000 ohms
Input Sensitivity—1.1 volt to 30 volts through gain control

POWER REQUIREMENTS:

117 volts to 125 volts at 50/60 Hz: 400 watts at zero signal output: 900 watts at rated output

SOLID STATE COMPLEMENT:

3—Silicon Transistors
3—Germanium Diodes
2—Silicon Zener Diodes
9—Silicon Rectifiers and Diodes

TUBE COMPLEMENT:

2—12AX7
2—6DJ8
1—6CG7
1—6BL7
8—6LQ6

MECHANICAL SPECIFICATIONS

DIMENSIONS:

Front Panel—10½ inches high x 19 inches wide
Chassis—17 inches behind panel including connections
Knobs project 2 inches in front of panel

FINISH:

Front Panel—Gold Anodized aluminum and black
Chassis—Chrome and black

WEIGHT:

Chassis only—125 pounds. In shipping crate 135 pounds.

Your MC 3500 power amplifier will give you many years of pleasant and satisfactory performance. If you have any questions concerning the operation or maintenance of this amplifier please contact your dealer or:

MC 3500 GUARANTEE

McIntosh Laboratory Incorporated guarantees this equipment to perform as advertised. We also guarantee the mechanical and electrical workmanship and components of this equipment to be free of defects for a period of 90 days from date of purchase. This guarantee does not extend to components damaged by improper use nor does it extend to transportation to and from the factory.

3 YEAR FACTORY SERVICE CONTRACT

An application for a FREE 3 YEAR FACTORY SERVICE CONTRACT is included in the pack with this manual. The FREE 3 YEAR FACTORY SERVICE CONTRACT will be issued by McIntosh Laboratory upon receipt of the completely filled out application form. The terms of this contract are defined in the 3 Year Factory Service Contract. If the application is not mailed to McIntosh Laboratory, only the service offered under the standard 90 day guarantee will apply on this equipment.

TAKE ADVANTAGE OF 3 YEARS OF FREE FACTORY
SERVICE BY FILLING IN THE APPLICATION NOW

CUSTOMER SERVICE

McIntosh Laboratory Inc.
2 Chambers Street
Binghamton, N.Y. 13903
Our telephone number is
607-723-3512

McIntosh
MC 3500

*McIntosh is the
Standard of Excellence because*

The McIntosh "will to perfection" requires that we probe constantly into the unknown to bring the performance of our electronic equipment closer to perfection than ever before. This requires a constant and relentless search for low noise, broad band conservative design with an ever lower distortion factor. This is not required of ordinary equipment of average designs. It is, for us, a costly but worthwhile scientific and engineering effort. Our continuing research benefits our customers with the almost complete lack of obsolescence and the most reliable equipment ever made. It also means the lowest long-range cost to you. Nearly all of the McIntosh equipment ever made is still useable, or in use, though it may have been made twenty years ago.

McIntosh

McINTOSH LABORATORY INC.

2 CHAMBERS ST., BINGHAMTON, N. Y. 13903

607-723-3512

Design subject to change without notice.
038-222

Printed in U.S.A.