

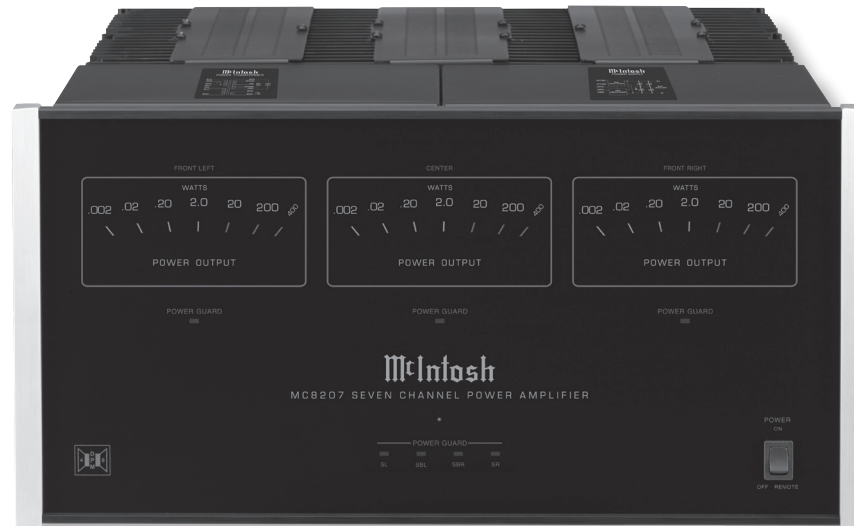

McIntosh Laboratory, Inc. 2 Chambers Street Binghamton, New York 13903-2699 Phone: 607-723-3512 www.mcintoshlabs.com

MC8207

Seven Channel
Power Amplifier
Owner's Manual



The lightning flash with arrowhead, within an equilateral triangle, is intended to alert the user to the presence of uninsulated “dangerous voltage” within the product’s enclosure that may be of sufficient magnitude to constitute a risk of electric shock to persons.

WARNING - TO REDUCE RISK OF FIRE OR ELECTRICAL SHOCK, DO NOT EXPOSE THIS EQUIPMENT TO RAIN OR MOISTURE.



AVIS RISQUE DE CHOC ELECTRIQUE - NE PAS OUVRIR.

NO USER-SERVICEABLE PARTS INSIDE. REFER SERVICING TO QUALIFIED PERSONNEL.

The exclamation point within an equilateral triangle is intended to alert the user to the presence of important operating and maintenance (servicing) instructions in the literature accompanying the appliance.

To prevent the risk of electric shock, do not remove cover or back. No user-serviceable parts inside.

IMPORTANT SAFETY INSTRUCTIONS!

PLEASE READ THEM BEFORE OPERATING THIS EQUIPMENT.

1. Read these instructions.
2. Keep these instructions.
3. Heed all warnings.
4. Follow all instructions.
5. Do not use this apparatus near water.
6. Clean only with a dry cloth.
7. Do not block any ventilation openings. Install in accordance with the manufacturer’s instructions.
8. Do not install near any heat sources such as radiators, heat registers, stoves, or other apparatus (including amplifiers) that produce heat.
9. Do not defeat the safety purpose of the polarized or grounding-type plug. A polarized plug has two blades with one wider than the other. A grounding type plug has two blades and a

third grounding prong. The wide blade or the third prong are provided for your safety. If the provided plug does not fit into your outlet, consult an electrician for replacement of the obsolete outlet.

10. Protect the power cord from being walked on or pinched particularly at plugs, convenience receptacles, and the point where they exit from the apparatus.
11. Only use attachments/accessories specified by the manufacturer.
12. Use only with the cart, stand, tripod, bracket, or table specified by the manufacturer, or sold with the apparatus. When a cart is used, use caution when moving the cart/apparatus combination to avoid injury from tip-over.
13. Unplug this apparatus during lightning storms or when unused for long periods of time.
14. Refer all servicing to qualified service personnel. Servicing is required when the apparatus has been damaged in any way, such as power-



supply cord or plug is damaged, liquid has been spilled or objects have fallen into the apparatus, the apparatus has been exposed to rain or moisture, does not operate normally, or has been dropped.

15. Do not expose this equipment to dripping or splashing and ensure that no objects filled with liquids, such as vases, are placed on the equipment.
16. To completely disconnect this equipment from the a.c. mains, disconnect the power supply cord plug from the a.c. receptacle.
17. The mains plug of the power supply cord shall remain readily operable.
18. Do not expose batteries to excessive heat such as sunshine, fire or the like.
19. Connect mains power supply cord only to a mains socket outlet with a protective earthing connection.

Thank You

Your decision to own this McIntosh MC8207 Power Amplifier ranks you at the very top among discriminating music listeners. You now have “The Best.” The McIntosh dedication to “Quality,” is assurance that you will receive many years of musical enjoyment from this unit.

Please take a short time to read the information in this manual. We want you to be as familiar as possible with all the features and functions of your new McIntosh.

Please Take A Moment

The serial number, purchase date and McIntosh Dealer name are important to you for possible insurance claim or future service. The spaces below have been provided for you to record that information:

Serial Number: _____

Purchase Date: _____

Dealer Name: _____

Technical Assistance

If at any time you have questions about your McIntosh product, contact your McIntosh Dealer who is familiar with your McIntosh equipment and any other brands that may be part of your system. If you or your Dealer wish additional help concerning a suspected problem, you can receive technical assistance for all McIntosh products at:

McIntosh Laboratory, Inc.
2 Chambers Street
Binghamton, New York 13903
Phone: 607-723-1545
Fax: 607-724-0549

Customer Service

If it is determined that your McIntosh product is in need of repair, you can return it to your Dealer. You can also return it to the McIntosh Laboratory Service Department. For assistance on factory repair return procedure, contact the McIntosh Service Department at:
McIntosh Laboratory, Inc.
2 Chambers Street
Binghamton, New York 13903
Phone: 607-723-3515
Fax: 607-723-1917

Table of Contents

Safety Instructions	2
Thank You and Please Take a Moment.....	3
Technical Assistance and Customer Service	3
Table of Contents	3
General Information	3-4
Connector and Cable Information	4
Introduction.....	4
Performance Features	4
Dimensions	5
Installation	6
Connections:	
Rear Panel Connections	7
How to Connect for a Seven Channel System	8-9
Connection Diagram (Separate Sheet)	Mc1A
How to Connect for a Five Channel and Zone B System (or Seven Channel System).....	10-11
Connection Diagram (Separate Sheet)	Mc1B
Front Panel Displays and Controls.....	12
How to Operate.....	13
Technical Description	14-15
Photos.....	16-17
Specifications.....	18
Packing Instruction.....	19

General Information

1. For additional connection information, refer to the owner’s manual(s) for any component(s) connected to the MC8207 Power Amplifier.
2. The Main AC Power going to the MC8207 and any other McIntosh Component(s) should not be applied until all the system components are connected together. Failure to do so could result in malfunctioning of some or all of the system’s normal operations. When the MC8207 and other McIntosh Components are in their Standby Power Off Mode, some of the circuitry inside each component is active and communication is occurring between them.
3. In the event the MC8207 overheats, due to improper ventilation and/or high ambient temperature, the protection circuits will activate. The Front Panel Power Guard LEDs will continuously indicate ON and the audio will be muted. When the MC8207 has returned to a safe operating temperature, normal operation will resume.
4. For the best performance and safety it is important to always match the impedance of the Loudspeaker to the Power Amplifier connections. Refer to “How to Connect” pages 8 thru 11.

Note: The impedance of a Loudspeaker actually varies as the Loudspeaker reproduces different frequencies. As a result, the nominal impedance rating of the Loudspeaker (usually measured at a midrange frequency) might not always agree with the impedance of the Loudspeaker at low frequencies where the greatest amount of power is required. Contact the Loudspeaker Manufacturer for additional information about the actual impedance of the Loudspeaker before connecting it to the McIntosh MC8207.

General Information, con't

- When discarding the unit, comply with local rules or regulations. Batteries should never be thrown away or incinerated but disposed of in accordance with the local regulations concerning battery disposal.
- For additional information on the MC8207 and other McIntosh Products please visit the McIntosh Web Site at www.mcintosh-labs.com.



Connector and Cable Information

XLR Connectors

Below is the Pin configuration for the XLR Balanced Input, Input/Output Connectors on the MC8207. Refer to the diagram for connection:

- PIN 1: Shield/Ground
- PIN 2: + Input/Output
- PIN 3: - Input/Output

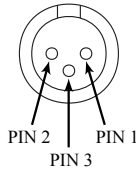

Power Control Connector

The MC8207 Power Control Input receives an On/Off signal from +5 to +12 volts. The Power Control Output will in turn provide a +12 volt Output Signal with a total current up to 50mA.

An additional connection is for controlling the illumination of the MC8207 Illumeter Power Output Indicators. The 1/8 inch stereo mini phone plug connects to a McIntosh Preamplifier or A/V Control Center Power Control Output.

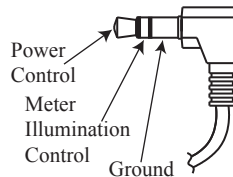

Introduction

Now you can take advantage of traditional McIntosh standards of excellence in the MC8207 Power Amplifier. The Seven Channel Power Amplifier produces a power output of 200 watts per channel and will drive quality Loudspeakers to a high level of performance. The MC8207 reproduction is sonically transparent and absolutely accurate. The McIntosh Sound is "The Sound of the Music Itself."

Performance Features

• Power Output

The MC8207 consists of Seven Power Amplifier Channels, each capable of 200 watts into 4 ohm or 8 ohm Loudspeakers with less than 0.005% distortion.

• Power Guard

The patented McIntosh Power Guard Circuit prevents the amplifier from being over driven into clipping, with its harsh distorted sound that can damage your valuable Loudspeakers.

• Dynamic Power Manager™

The MC8207's Dynamic Power Manager (DPM) circuitry allows for the connection of either 4 ohm or 8 ohm Loudspeakers, while at the same time delivering identical power output. A peak output current of 25 amperes per channel ensures that it will successfully drive high quality Loudspeakers such as McIntosh, for a truly exciting sound experience.

• Versatile Operation

The MC8207 can provide power amplification for seven channels in a single Zone A/V System or five channels for Zone A and two channels for Zone B in a Dual Zone A/V System.

• Balanced and Unbalanced Inputs

There are Balanced Connections for all seven Power Amplifier Input Channels. For convenience when the MC8207 is used in a Dual Zone System there are also two unbalanced inputs.

• Sentry Monitor and Thermal Protection

McIntosh Sentry Monitor power output stage protection circuits ensure the MC8207 will have a long and trouble free operating life. Built-in thermal protection circuits guard against overheating.

• Illumeter Power Output Indicators

The LED Illumeter Power Output Indicators are peak responding and indicate the power output of the amplifier in watts.

• Power Control

The McIntosh Power Control Circuit allows for remote turn-on of the MC8207 Power Amplifier from a McIntosh A/V Control Center or Preamplifier for a single or dual Zone System.

• Special Power Supply

A regulated Power Supply and a very large Toroidal Wound Power Transformer, ensures stable noise free operation even though the power line varies.

• Fiber Optic Solid State Front Panel Illumination

The even Illumination of the Front Panel is accomplished by the combination of custom designed Fiber Optic Light Diffusers and extra long life Light Emitting Diodes (LEDs). The glass Front Panel ensures the pristine beauty of the MC8207 will be retained for many years.

Dimensions

The following dimensions can assist in determining the best location for your MC8207.

Front View of the MC8207

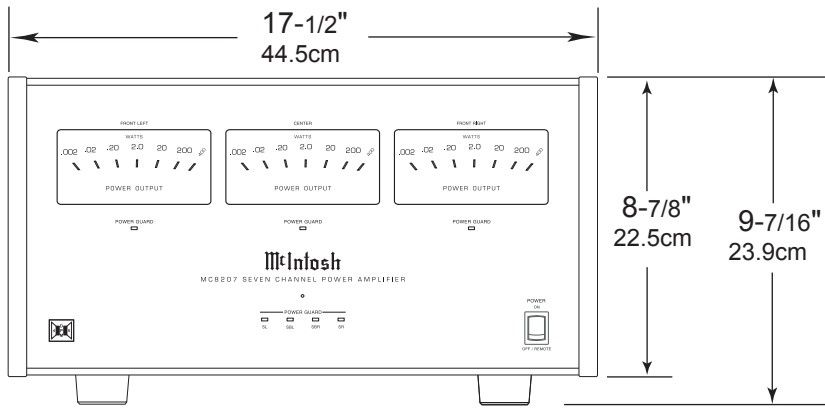

Rear View of the MC8207

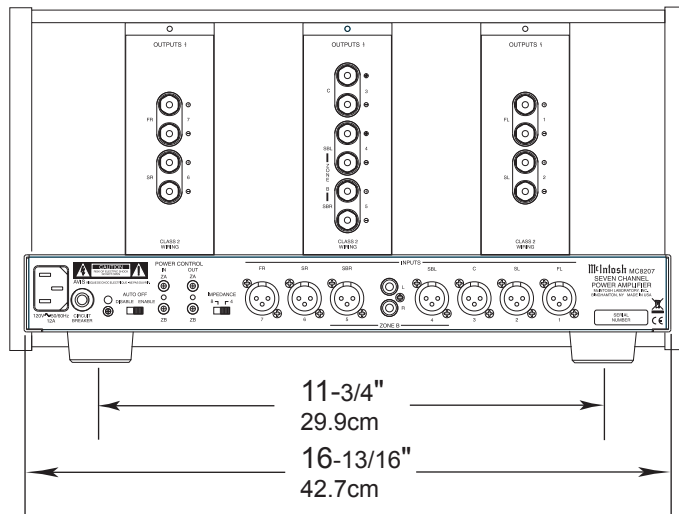

Side View of the MC8207

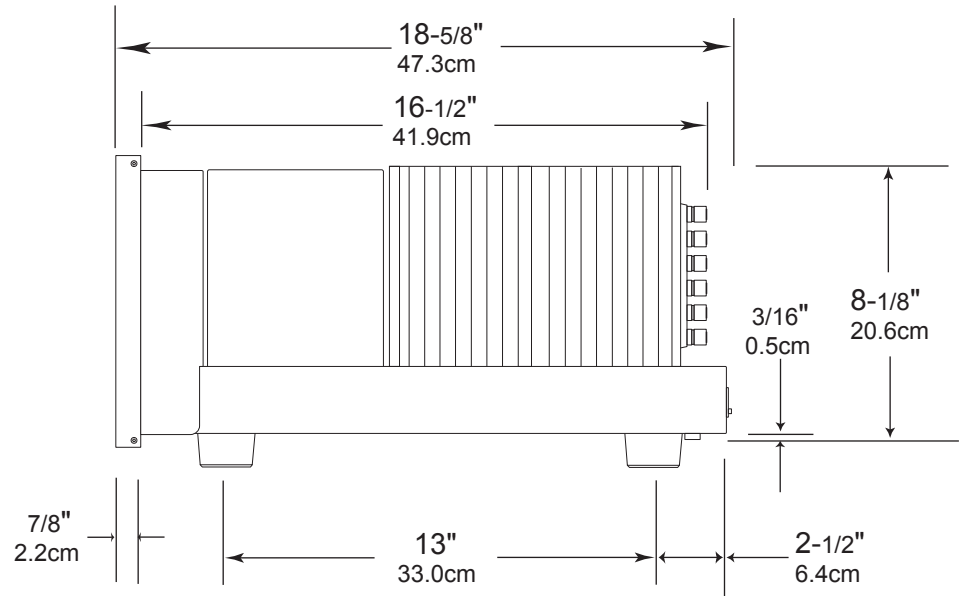

Installation

The MC8207 can be placed upright on a table or shelf, standing on its four feet. It also can be custom installed in a piece of furniture or cabinet of your choice. The four feet may be removed from the bottom of the MC8207 when it is custom installed as outlined below. The four feet together with the mounting screws should be retained for possible future use if the MC8207 is removed from the custom installation and used free standing. The required panel cutout, ventilation cutout and unit dimensions are shown.

Always provide adequate ventilation for your MC8207. Cool operation ensures the longest possible operating life for any electronic instrument. Do not install the MC8207 directly above a heat generating component such as a high powered amplifier. If all the components are installed in a single cabinet, a quiet running ventilation fan can be a definite asset in maintaining all the system components at the coolest possible operating temperature.

A custom cabinet installation should provide the following minimum spacing dimensions for cool operation.

Allow at least 6 inches (15.24cm) above the top, 2 inches (5.08cm) below the bottom, 3 inches (7.62cm) behind the rear panel and 2 inches (5.08cm) on each side of the Power Amplifier, so that airflow is not obstructed. Allow 2-1/2 inches (6.35 cm) in front of the mounting¹ panel for clearance. Be sure to cut out a ventilation hole in the mounting shelf according to the dimensions in the drawing.

¹ When the MC8207 is installed together with other McIntosh Components, check clearances on all components before proceeding.

**MC8207 Front Panel
Custom Cabinet Cutout**

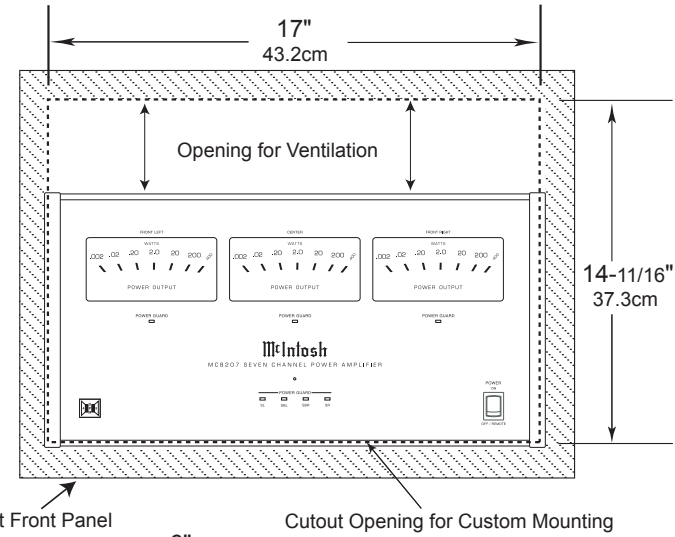

**MC8207 Side View
in Custom Cabinet**

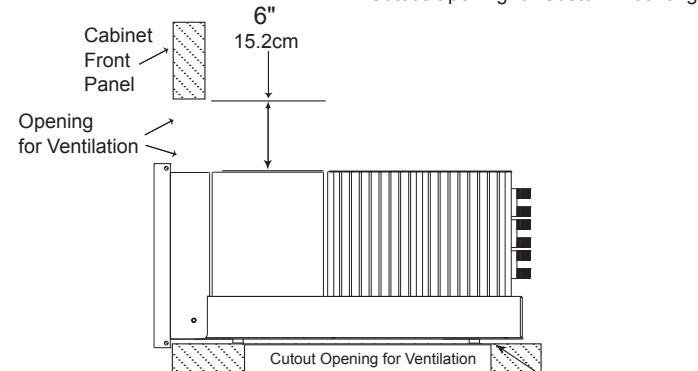

**MC8207 Bottom View
in Custom Cabinet**

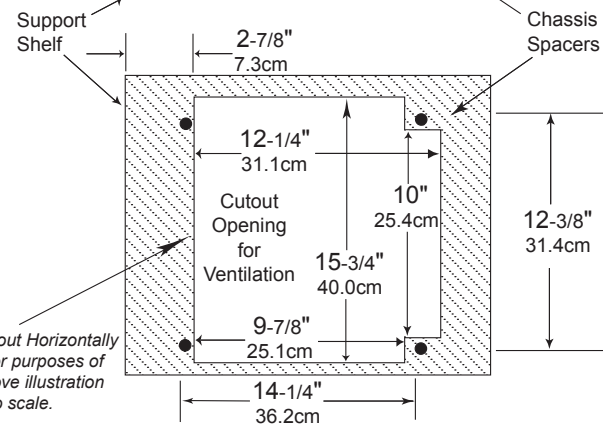

Note: Center the cutout horizontally on the unit. For purposes of clarity, the above illustration is not drawn to scale.

Rear Panel Connections and Switch

OUTPUTS Channel 7 (Front Right) connection for a 4 ohm or 8 ohm Loudspeaker

OUTPUTS Channel 3 (Center) connection for a 4 ohm or 8 ohm Loudspeaker

OUTPUTS Channel 1 (Front Left) connection for a 4 ohm or 8 ohm Loudspeaker

OUTPUTS Channel 6 (Surround Right) connection for a 4 ohm or 8 ohm Loudspeaker

OUTPUTS Channel 5 (Surround Back Right) or ZONE B Right Channel connection for a 4 ohm or 8 ohm Loudspeaker

OUTPUTS Channel 4 (Surround Back Left) or ZONE B Left Channel connection for a 4 ohm or 8 ohm Loudspeaker

OUTPUTS Channel 2 (Surround Left) connection for a 4 ohm or 8 ohm Loudspeaker

Circuit Breaker, press to reset if the amplifier will not power up

Connect the MC8207 power cord to a live AC outlet. Refer to the rear panel to determine the correct voltage

Unbalanced INPUTs ZONE B Right Channel or Channel 5 (Surround Back Right) and ZONE B Left Channel or Channel 4 (Surround Back Left)

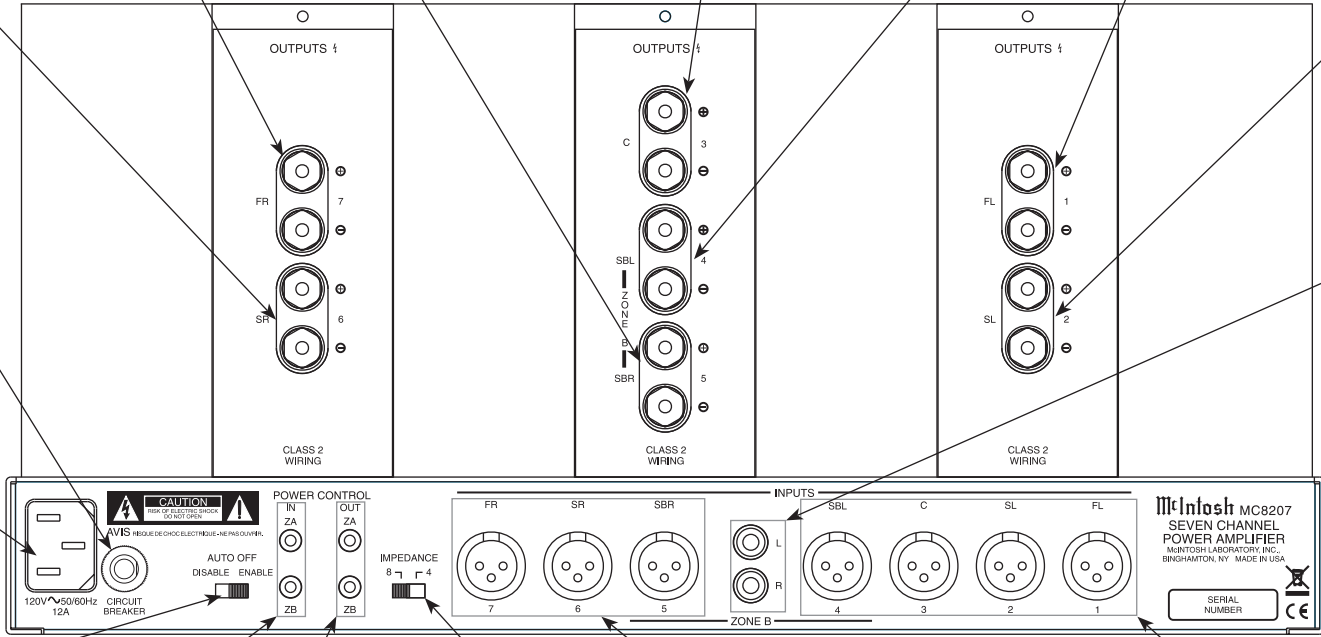

AUTO OFF Disables or Enables the Power Saving Circuitry¹

POWER CONTROL OUT (ZA and ZB) send turn On/Off signals to the next McIntosh Component

Balanced INPUTs Channel 7 (Front Right); Channel 6 (Surround Right); Channel 5 (Surround Back Right or ZONE B Right Channel)

POWER CONTROL IN (ZA) receives turn On/Off signals from a McIntosh component for Zone A (Channels 1- 7). POWER CONTROL IN (ZB) receives turn On/Off signals from a McIntosh component for Zone B (Channels 4 and 5).

Selects the impedance (4 or 8 ohms) of the Loudspeakers connected to the MC8207

Balanced INPUTs Channel 4 (Surround Back Left or ZONE B Left Channel); Channel 3 (Center); Channel 2 (Surround Left); Channel 1 (Front Left)

¹ Refer to page 13 for additional information



How to Connect for Seven Channel System

Caution: Do not connect the AC Power Cord to the MC8207 Rear Panel until after the Loudspeaker Connections are made and the protective Terminal Connections Cover is installed. Failure to observe this could result in Electric Shock.

The connection instructions below, together with the MC8207 Connection Diagram located on the separate folded sheet “Mc1A”, is an example of a typical Multichannel System. Your system may vary from this, however the actual components would be connected in a similar manner. For additional information refer to “Connector and Cable Information” on page 4.

1. For Remote Power Control, connect a power control cable from the A/V Control Center Power Control Trigger/Output 1 to the Amplifier POWER CONTROL ZA input.

Note: When the Power Control Cable is connected between the MC8207 and an A/V Control Center, the AUTO OFF Signal Sensing Circuitry is automatically disabled.

2. Connect XLR cables from the Balanced Outputs (FL, C, FR, SR, SL, SBR and SBL) of an A/V Control Center to the MC8207 Balanced INPUTS (1-FL, 3-C, 7-FR, 6-SR, 2-SL, 5-SBR and 4-SBL) making sure to match up channel designations.

This McIntosh MC8207 Power Amplifier is designed for Loudspeakers with an impedance of 4 ohms or 8 ohms. Connect a single Loudspeaker only to each Channel Output Terminals.

When connecting Loudspeakers to the MC8207 it is very important to use cables of adequate size, so there is little to no power loss in the cables. The size is specified in Gauge Numbers or AWG (American Wire Gauge). The smaller the Gauge number, the larger the wire size:

Loudspeaker Cable Distance vs Wire Gauge Guide			
Loudspeaker Impedance	25 feet (7.62 meters) or less	50 feet (15.24 meters) or less	100 feet (30.48 meters) or less
2 Ohms	12AWG	10AWG	8AWG
4 Ohms	14AWG	12AWG	10AWG
8 Ohms	16AWG	14AWG	12AWG

3. Prepare the Loudspeaker Hookup Cable for attachment to the MC8207 Power Amplifier:

Bare wire cable ends:

Carefully remove sufficient insulation from the cable ends, refer to figures 1, 2 & 3. If the cable is stranded, carefully twist the strands together as tightly as possible.

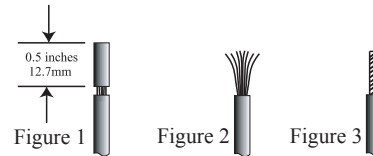

- Notes:
1. If desired, the twisted ends can be tinned with solder to keep the strands together.
 2. The prepared bare wire cable ends may be inserted into spade lug connectors.
 3. Banana plugs are for use in the United States and Canada only.

Banana Plugs are for use in the United States and Canada only:

4. Attach the previously prepared bare wire cable ends into the banana plugs and secure the connections. Refer to figure 4.

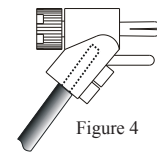

5. Referring to figure 5, connect the Loudspeaker hookup cables with banana plugs into the hole at the end of the MC8207 Negative and Positive Output Terminals, making sure to match up channel designation with Loudspeaker location.
6. Place the IMPEDANCE Switch to the position (4 ohm or 8 ohm) to match the impedance of the connected Loudspeakers. In the event that some of the Loudspeakers in the system are different impedance, use the impedance of the Front Loudspeakers. If the Loudspeaker’s impedance is 6 ohms, select the 4 ohms setting. Refer to “General Information” Note 4 on page 3 for additional information.

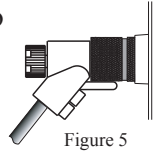

WARNING: Loudspeaker terminals are hazardous live and present a risk of electric shock. For additional instruction on making Loudspeaker Connections contact your McIntosh Dealer or McIntosh Technical Support.

7. Connect the MC8207 power cord to an active AC outlet.

Spade Lug or Wire Connections:

8. Connect the Loudspeaker hookup cables to the MC8207 Output Terminal being careful to observe the correct polarities, making sure to match up channel designation with Loudspeaker location. Insert the spade lug connector or prepared section of the cable end into the terminal side access hole. Then tighten the terminal cap until the cable is firmly clamped into the terminals so the lugs or wire cannot slip out. Refer to figures 6, 7 and 8.

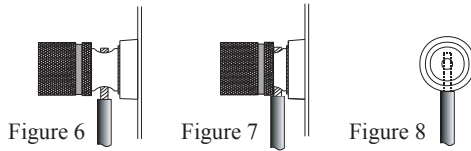

9. Place the IMPEDANCE Switch to the position (4 ohm or 8 ohm) to match the impedance of the connected Loudspeakers. In the event that some of the Loudspeakers in the system are different impedance, use the impedance of the Front Loudspeakers. If the Loudspeaker's impedance is 6 ohms, select the 4 ohms setting. Refer to "General Information" Note 4 on page 3 for additional information.

WARNING: Loudspeaker terminals are hazardous live and present a risk of electric shock. For additional instruction on making Loudspeaker Connections contact your McIntosh Dealer or McIntosh Technical Support.

10. Connect the MC8207 power cord to an active AC outlet.

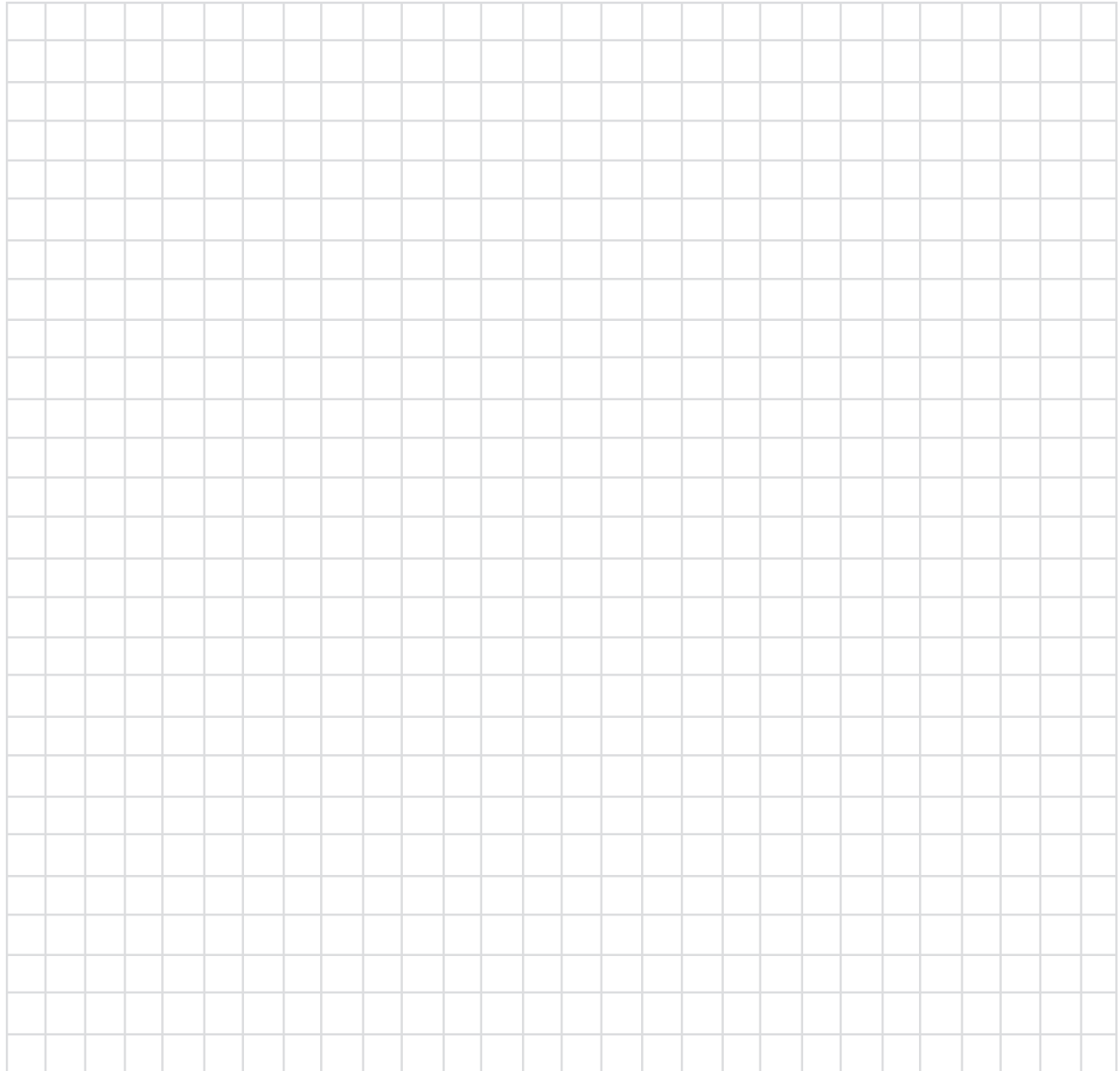



How to Connect for a Five Channel and Zone B System

Caution: Do not connect the AC Power Cord to the MC8207 Rear Panel until after the Loudspeaker Connections are made and the protective Terminal Connections Cover is installed. Failure to observe this could result in Electric Shock.

The connection instructions below, together with the MC8207 Connection Diagram located on the separate folded sheet “Mc1B”. Below is an example of a typical Five Channel and Zone B System. Your system may vary from this, however the actual components would be connected in a similar manner. For additional information refer to “Connector and Cable Information” on page 4.

1. For Remote Power Control, connect a power control cable from the A/V Control Center Power Control Trigger/Output 1 to the Amplifier POWER CONTROL ZA In. Also connect a power control cable from the A/V Control Center Power Control Trigger/Output 2 to the Amplifier POWER CONTROL ZB In.

Note: 1. When the Power Control Cable is connected between the MC8207 Power Control ZA In Jack and an A/V Control Center, the AUTO OFF Signal Sensing Circuitry is automatically disabled.

2. For proper operation of Zone B, a Power Control Connection is required between the MC8207 Power Control ZB In Jack and an A/V Control Center Power Control Zone B Output Jack.

2. Connect XLR cables from the Balanced Outputs (FL, C, FR, SR, SL, SBR and SBL) of an A/V Control Center to the MC8207 Balanced INPUTS (1-FL, 3-C, 7-FR, 6-SR and 2-SL), making sure to match up channel designations.

3. Connect audio cables from the A/V Control Center Zone B Left and Right Channel Outputs to the MC8207 Unbalanced L(4-SBL) and R(5-SBR), making sure to match up channel designation.

Note: If the A/V Control Center Zone B Left and Right Channel Outputs are Balanced Connectors, then use XLR Cables and connect them to the Balanced Inputs 4-SBL for the Left Channel and 5-SBR for the Right Channel.

This McIntosh MC8207 Power Amplifier is designed for Loudspeakers with an impedance of 4 ohms or 8 ohms. Connect a single Loudspeaker only to each Channel Output Terminals.

When connecting Loudspeakers to the MC8207 it is very important to use cables of adequate size, so there is little to no power loss in the cables. The size is specified in Gauge Numbers or AWG (American Wire Gauge). The smaller the Gauge number, the larger the wire size:

Loudspeaker Cable Distance vs Wire Gauge Guide			
Loudspeaker Impedance	25 feet (7.62 meters) or less	50 feet (15.24 meters) or less	100 feet (30.48 meters) or less
2 Ohms	12AWG	10AWG	8AWG
4 Ohms	14AWG	12AWG	10AWG
8 Ohms	16AWG	14AWG	12AWG

4. Prepare the Loudspeaker Hookup Cable for attachment to the MC8207 Power Amplifier:

Bare wire cable ends:

Carefully remove sufficient insulation from the cable ends, refer to figures 1, 2 & 3.

If the cable is stranded, carefully twist the strands together as tightly as possible.

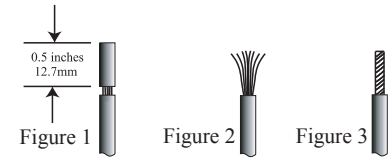

- Notes:*
1. If desired, the twisted ends can be tinned with solder to keep the strands together.
 2. The prepared bare wire cable ends may be inserted into spade lug connectors.
 3. Banana plugs are for use in the United States and Canada only.

Banana Plugs are for use in the United States and Canada only:

5. Attach the previously prepared bare wire cable ends into the banana plugs and secure the connections. Refer to figure 4.

6. Referring to figure 5, connect the Loudspeaker hookup cables with banana plugs into the hole at the end of the MC8207 Negative and Positive Output Terminals, making sure to match up channel designation with Loudspeaker location.

7. Place the IMPEDANCE Switch to the position (4 ohm or 8 ohm) to match the impedance of the connected Loudspeakers. In the event that some of the Loudspeakers in the system are different impedance, use the impedance of the Front Loudspeakers. If the Loudspeaker's impedance is 6 ohms, select the 4 ohms setting. Refer to “General Information” Note 4 on page 3 for additional information.

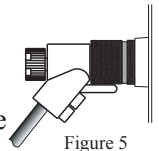
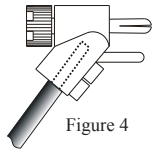

WARNING: Loudspeaker terminals are hazardous live and present a risk of electric shock. For additional instruction on making Loudspeaker Connections contact your McIntosh Dealer or McIntosh Technical Support.

8. Connect the MC8207 power cord to an active AC outlet.

Spade Lug or Wire Connections:

9. Connect the Loudspeaker hookup cables to the MC8207 Output Terminal being careful to observe the correct polarities, making sure to match up channel designation with Loudspeaker location. Insert the spade lug connector or prepared section of the cable end into the terminal side access hole. Then tighten the terminal cap until the cable is firmly clamped into the terminals so the lugs or wire cannot slip out. Refer to figures 6, 7 and 8.

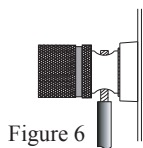

Figure 6

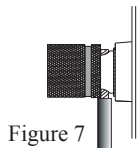

Figure 7

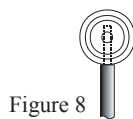

Figure 8

10. Place the IMPEDANCE Switch to the position (4 ohm or 8 ohm) to match the impedance of the connected Loudspeakers. In the event that some of the Loudspeakers in the system are different impedance, use the impedance of the Front Loudspeakers. If the Loudspeaker's impedance is 6 ohms, select the 4 ohms setting. Refer to "General Information" Note 4 on page 3 for additional information.

WARNING: Loudspeaker terminals are hazardous live and present a risk of electric shock. For additional instruction on making Loudspeaker Connections contact your McIntosh Dealer or McIntosh Technical Support.

11. Connect the MC8207 power cord to an active AC outlet.



LED indicates when the Front Left, Center or Front Right Amplifier Channel POWER GUARD circuit activates

Illumeter indicates the Power Output of the Front Left, Center and Front Right Amplifier Channels

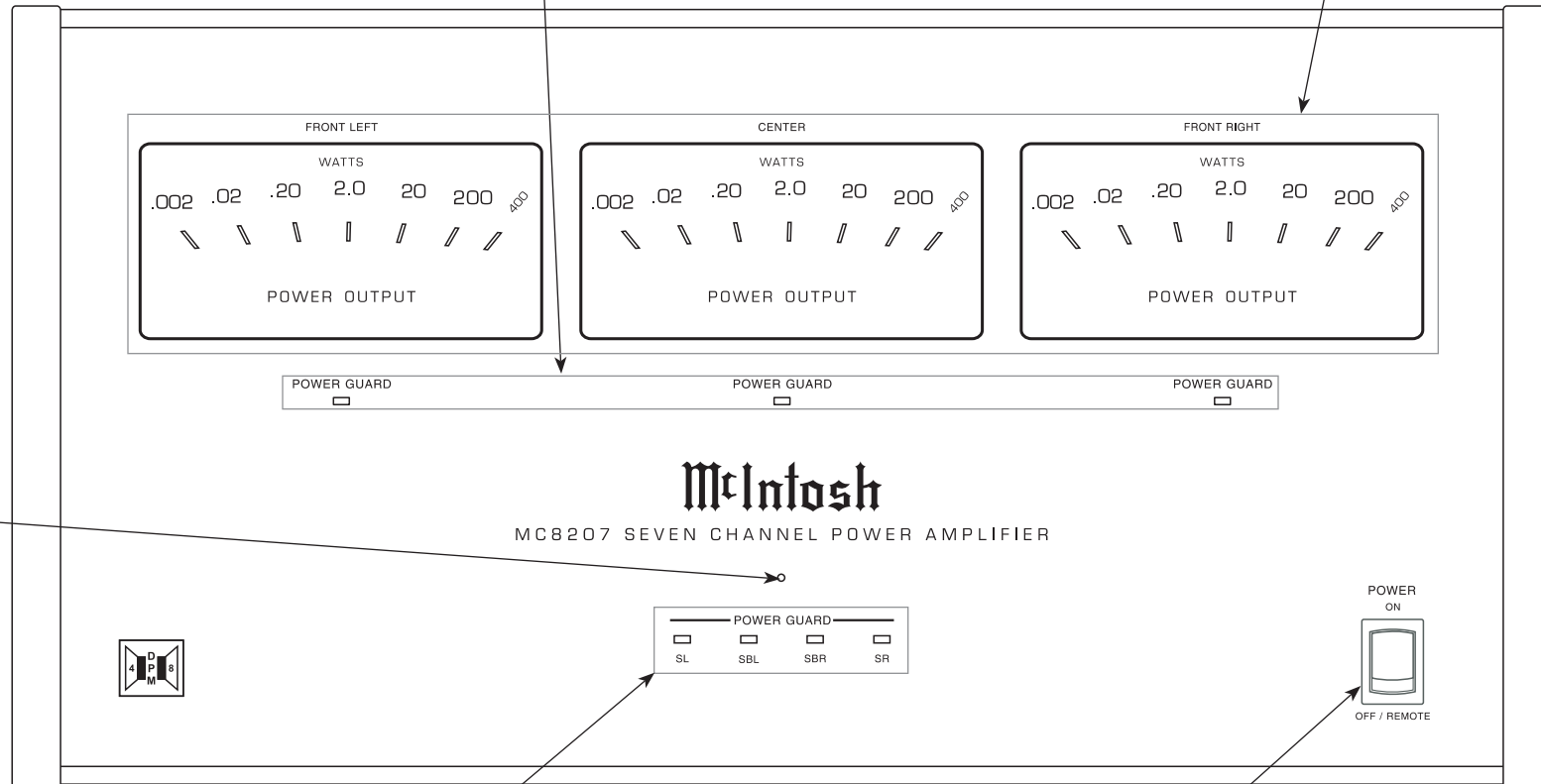

Standby Power On Indicator

LED indicates when the SL, SBL, SBR or SR Amplifier Channel POWER GUARD circuit activates

POWER Switch Turns AC Power On or Off/Remote (On/Off)

How to Operate

Power

With the POWER Switch set to the OFF/REMOTE Position, the MC8207 will turn On or Off when an A/V Control Center turns On or Off. For manual operation, place the POWER Switch to the ON Position as desired. Refer to figure 9.

Notes: 1. There must be a power control connection between the MC8207 and the McIntosh A/V Control Center in order for the remote power turn-on to function.

2. To switch the MC8207 back On after the Auto Sense Circuitry has placed the amplifier into the Standby Mode, it is first necessary to place the POWER Switch in the OFF/REMOTE position. Then place the POWER Switch in the ON position. Refer to "Auto Off Switch" below for additional information.

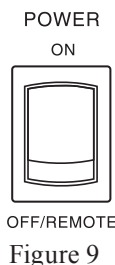

Figure 9

Auto Off Switch

The MC8207 incorporates Power Save Circuitry to automatically place the MC8207 into the power saving Standby Mode approximately 30 minutes after there has been an absence of an audio input signal.

When there is a Power Control Connection between the MC8207 and a Preamplifier with Power Save Circuitry, the AUTO OFF Switch is bypassed (located on the Rear Panel Of the MC8207). Refer to figure 10.



Figure 10

In the event there is no Power Control Connection and the Power Save Circuitry is activating inappropriately relative to your specific use of the MC8207, place the AUTO OFF Switch in the DISABLE position.

Note: If the Power Save Circuitry has switched Power to the MC8207 OFF, place the POWER in the OFF Position and then in the ON position to reset the circuitry.

Impedance Switch

The MC8207's Dynamic Power Manager circuitry allows for the connection of either 4 ohm or 8 ohm Loudspeakers to its output terminals, while at the same time delivering the same power output. Refer to figure 11.

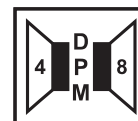

Figure 11

Place the IMPEDANCE Switch, located on the rear panel, to the position (4 ohm or 8 ohm) that matches the impedance of the connected Loudspeakers. In the event that some of the Loudspeakers in the system are of different impedance, use the impedance of the Left and Right Front Loudspeakers to set the IMPEDANCE Switch position. Refer to figure 12.



Figure 12

Illumeter Power Output Indicators

The MC8207 Illumeter Power Output Indicators are calibrated to allow for the direct reading of the Power Output in Watts for Loudspeakers connected to Front Left, Center and Front Right Amplifier Channels. The Illumeter responds to all the musical information being produced by the amplifier. It indicates to an accuracy of at least 95% of the power output with only a single cycle of a 2000Hz tone burst. Refer to figure 13.

Note: When Power Control Input of the MC8207 is connected to a A/V Control Center or Audio Preamplifier with Remote Meter Illumination Control, the Illumbar Illumination will automatically be remotely controlled (On/Off).

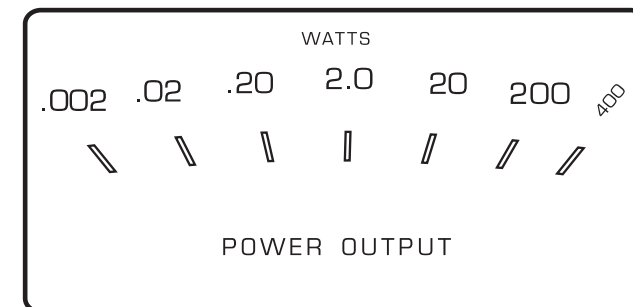

Figure 13



Technical Description

A continuous average power output rating of 200 watts and an output current of greater than 25 amperes per channel, makes this one of the most advanced and powerful amplifiers McIntosh has ever manufactured. Refer to figures 14 and 16. The distortion limits for the MC8207 are no more than 0.005% at rated power output for all frequencies from 20Hz to 20,000Hz. Typical performance at mid frequencies is less than 0.002%. The true distortion readings on the MC8207 are so low, it takes special measuring techniques to make accurate readings. The MC8207 can deliver the best possible performance from any type of high quality Loudspeaker System.

Design Philosophy

The MC8207 McIntosh Power Amplifier uses the recently developed Dynamic Power Manager™ (DPM) Circuitry. The MC8207 can easily drive 4 ohm speakers, with their high current demand. Additionally, the MC8207 can be used with 8 ohm speakers, and deliver equal power. McIntosh's new DPM™ design enables it to run on higher voltage rails when connected to

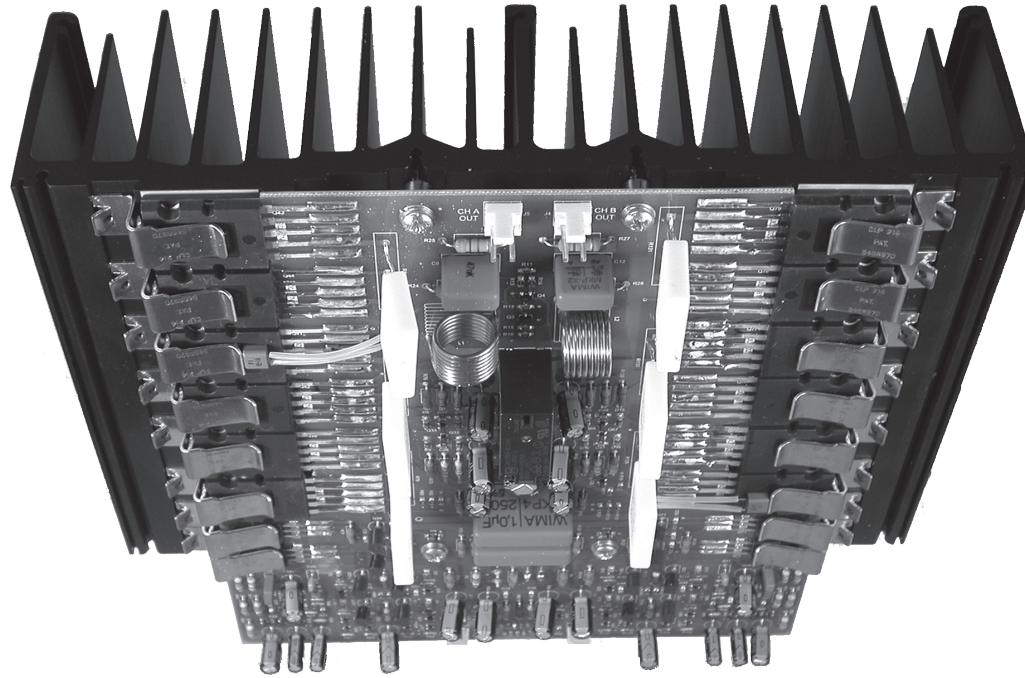

Figure 14

less current-hungry 8 ohm speakers and still deliver 200 watts. The power penalty usually paid with 8 ohm speakers on high current amplifiers does not exist with this new design.

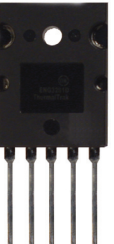

Figure 15

All transistors are selected to have nearly constant current gain over the entire current range they must cover. Output transistors in particular, have matched uniform current gain, high current bandwidth product and large active region safe operating

area. These Power Transistors are the very latest in semiconductor technology and incorporate a new design known as ThermalTrak™. Refer to figure 15. This allows for the instantaneous and accurate monitoring of the Power Transistor Temperature. The MC8207 Power Output Circuitry has a specially designed bias circuit to take full advantage of the ThermalTrak™ Power Transistors and thus precisely controls the power amplifier operation over a wide range of music conditions with the benefits of lower distortion and cooler operation. Precision metal film resistors and low dielectric absorption film capacitors are used in all critical circuit locations.

Block Diagram of the Power Amplifier (one channel shown)

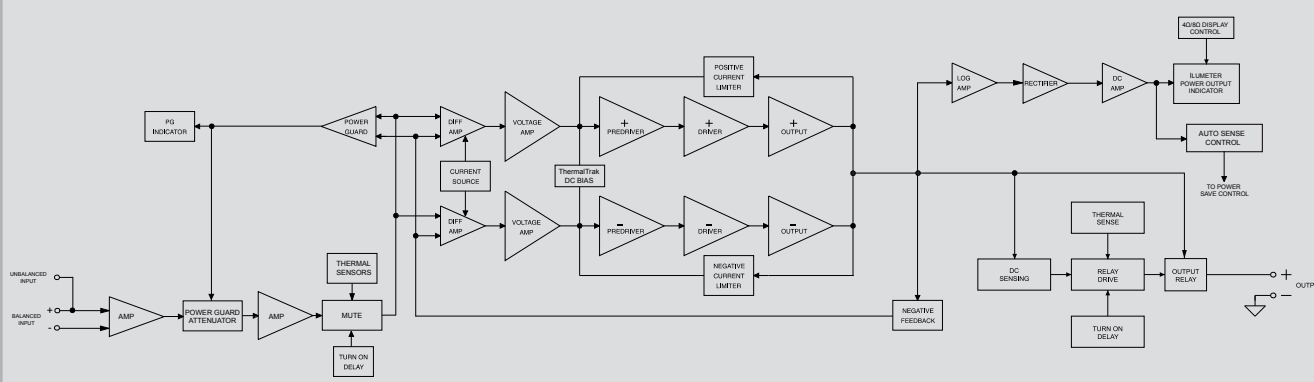

Figure 16

The high efficiency circuit design of the MC8207 contributes to low operating temperatures. More than 2100 square inches of heat sink area occupies almost half of the MC8207's chassis space and keeps the amplifier operating safely with convection cooling. No fans are needed.

Protection Circuits

The MC8207 incorporates its version of the McIntosh Sentry Monitor output transistor protection circuit. There is absolutely no compromise in sonic performance with this circuit, and it ensures safe operation of the amplifier under even the most extreme operating conditions. Refer to figure 17. The different types of protection circuits incorporated in the MC8207 insure a long and safe operating life.

The MC8207 also includes the unique patented McIntosh Power Guard circuit. Power Guard eliminates the possibility of ever overdriving the amplifier into clipping. Refer to figures 18, 19 and 20. An overdriven amplifier can produce both audible and inaudible distortion levels exceeding 40%. The audible distortion is unpleasant to hear, but the inaudible ultrasonic distortion is also undesirable, since it can damage valuable

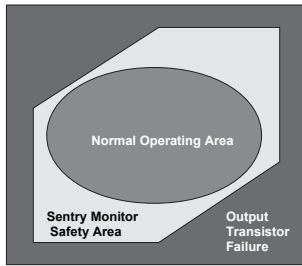

Figure 17

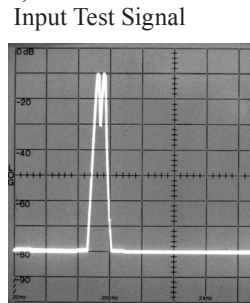

Figure 18

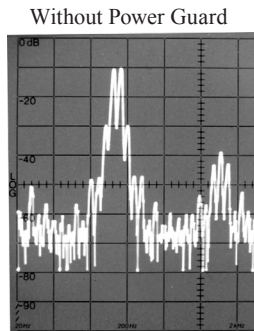

Figure 19

Loudspeaker System tweeters. You will never experience the harsh and damaging distortion due to clipping.

The Power Guard circuit is a waveform comparator, monitoring both the input and output waveforms. Under normal operating conditions, there are no differences between the shapes of these waveforms. If an amplifier channel is overdriven, there will be a difference between the two signal waveforms. When the difference exceeds 0.3% (equivalent to 0.3% harmonic distortion), the Power Guard activates the PG light and a dynamic electronic attenuator at the amplifier input reduces the input volume just enough to prevent any further increase in distortion. The Power Guard circuit acts so fast that there are absolutely no audible side effects and the sonic purity of the music reproduction is perfectly preserved. The MC8207 Power Amplifier with Power Guard is not limited to just the rated power output, but will actually produce distortion free output well above its rated power due to the McIntosh philosophy of conservative design.

Power Supply Circuits

To compliment the design of the MC8207, there is a high current power supply for the five power amplifier channels. Refer to figure 21. The

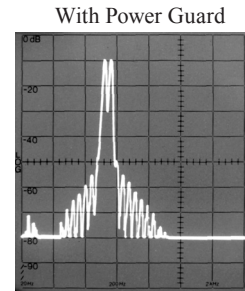

Figure 20

very large Power Transformer, has toroidal windings on a toroidal core and can supply over 35 amps of continuous current. Refer to figure 22 (golf ball is for size comparison). It is enclosed in the legendary McIntosh Potted Enclosures and weighs over 12kg. The super size main filter capacitors can store over 340 Joules of energy for the seven amplifier channels, necessary for the wide dynamic range that "Digital Audio" demands. The power amplifier draws high current from the AC power line. Therefore, it is important that they plug directly into the wall outlet. Also, most owners desire one power switch for the whole audio system. The MC8207 is equipped with a circuit that provides remote Power Control from a McIntosh A/V Control Center. When the A/V Control Center is switched On, a (+5V) signal operates the power relay in the MC8207. The MC8207 also has a remote Power Control input for Zone B operation (two of the seven channels).



Figure 22

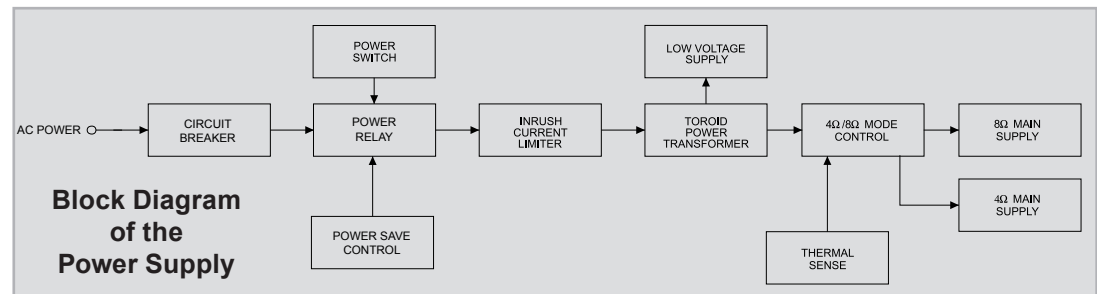

Figure 21







Specifications

Power Output

Minimum sine wave continuous average power output per channel, all channels operating is:
200 watts into a 4 ohm or 8 ohm load

Output Load Impedance

8 and 4 ohms

Rated Power Band

20Hz to 20,000Hz

Total Harmonic Distortion

0.005% maximum harmonic distortion at any power level from 250 milliwatts to rated power, 20Hz to 20,000Hz

Dynamic Headroom

1.7dB

Frequency Response

+0, -0.25dB from 20Hz to 20,000Hz
+0, -3dB from 10Hz to 100,000Hz

Input Sensitivity (for rated output)

2.0 Volt Balanced with a 4 ohm Loudspeaker
1.0 Volt Unbalanced with a 4 ohm Loudspeaker
2.8 Volt Balanced with a 8 ohm Loudspeaker
1.4 Volt Unbalanced with a 8 ohm Loudspeaker

Signal To Noise Ratio (A-Weighted)

112dB below rated output

Intermodulation Distortion

0.005% maximum, if the instantaneous peak power output does not exceed twice the rated power output or less per channel with all channels operating for any combination of frequencies from 20Hz to 20,000Hz.

Wide Band Damping Factor

Greater than 70 at 4 ohms
Greater than 140 at 8 ohms

Input Impedance

20,000 ohms Balanced
10,000 ohms Unbalanced

Voltage Gain

29dB

Power Guard

Less than 2% THD with up to 14dB overdrive at 1,000Hz

Power Control Inputs ZA and ZB

5-15VDC, less than 1mA

Power Control Output ZA and ZB

12VDC, 50mA maximum total
Output is delayed 0.2 seconds from turn On

Power Requirements

Field AC Voltage conversion of the MC8207 is not possible. The MC8207 is factory configured for one of the following AC Voltages:

100 Volts, 50/60Hz at 14.4 Amps
110 Volts, 50/60Hz at 13.0 Amps
120 Volts, 50/60Hz at 12.0 Amps
220 Volts, 50/60Hz at 7.5 Amps
230 Volts, 50/60Hz at 6.5 Amps
240 Volts, 50/60Hz at 6.5 Amps

Standby: less than 0.5 watt

Note: Refer to the rear panel of the MC8207 for the correct voltage.

Overall Dimensions

Width is 17-1/2 inches (44.5cm)
Height is 9-7/16 inches (23.9cm) including feet
Depth is 21 inches (53.3cm) including the Front Panel and Cables

Weight

83 pounds (37.6 kg) net, 116 pounds (52.6 kg) in shipping carton

Shipping Carton Dimensions

Width is 29-1/2 inches (74.9cm)
Height is 17 inches (43.2cm)
Depth is 29 inches (73.7cm)

Packing Instructions

In the event it is necessary to repack the equipment for shipment, the equipment must be packed exactly as shown below. It is very important that the four plastic feet are attached to the bottom of the equipment. Four 1/4 - 20x2-1/4 inch screws and washers must be used to fasten the unit securely to the bottom pad and wood skid. This will ensure the proper equipment location on the bottom pad. Failure to do this will result in shipping damage.

Use the original shipping carton and interior parts only if they are all in good serviceable condition. If a shipping carton or any of the interior part(s) are needed, please call or write Customer Service Department of McIntosh Laboratory. Refer to page 3. Please see the Part List for the correct part numbers.

Quantity	Part Number	Description
1	034052	Shipping carton top
1	034051	Shipping carton bottom
2	034054	Foam Pad (top and bottom)
2	034186	Foam Pad (front and rear)
2	034187	Foam Pad (sides)
1	034136	Inner carton top
1	034137	Inner carton bottom
1	034188	Foam Pad (inner carton)
1	034479	Shipping skid
4	401212	1/4 - 20x2-1/4 cap screw
4	104058	Flat washer

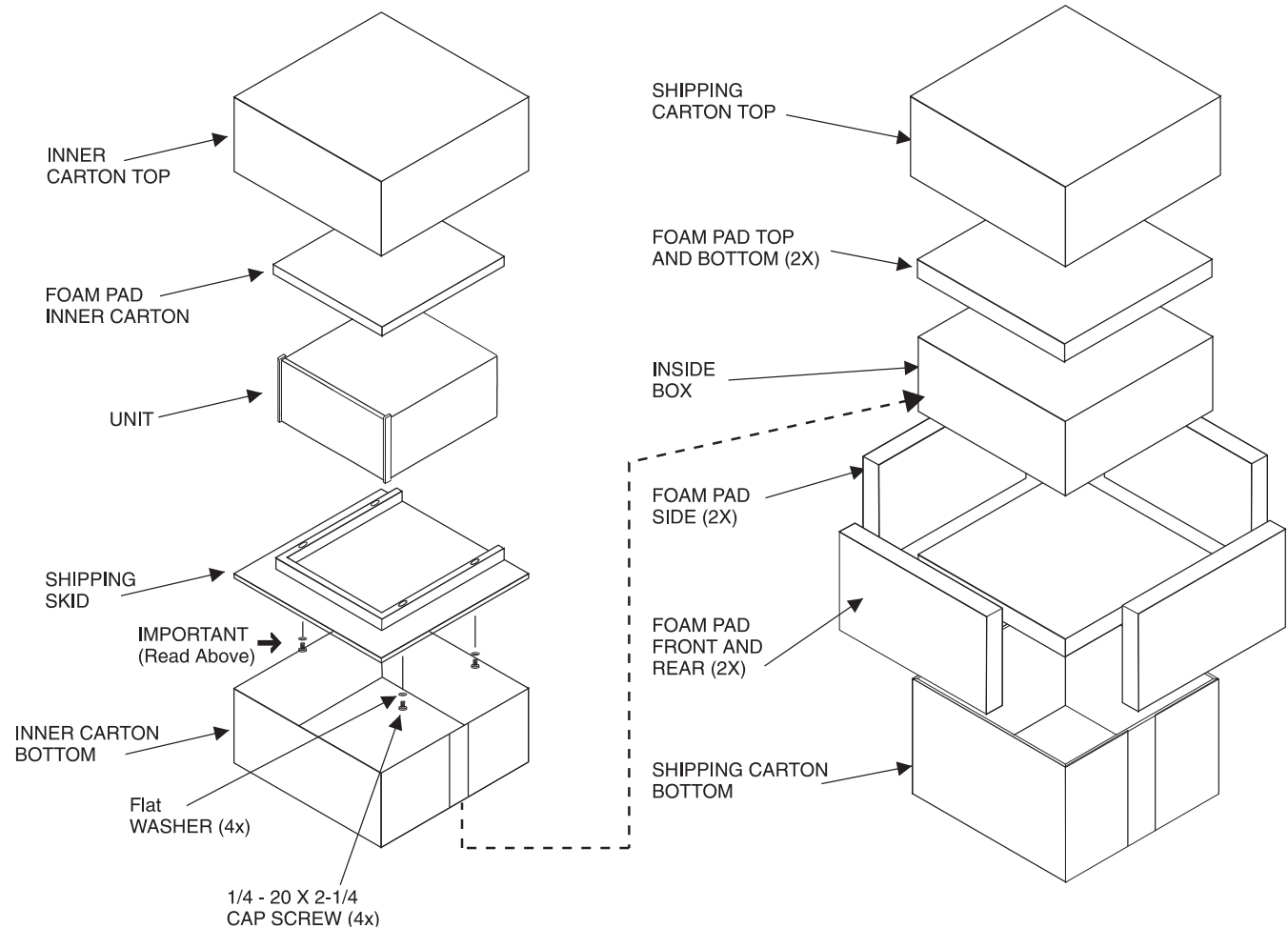



McIntosh Laboratory, Inc.
2 Chambers Street
Binghamton, NY 13903
www.mcintoshlabs.com

The continuous improvement of its products is the policy of McIntosh Laboratory Incorporated who reserve the right to improve design without notice.
Printed in the U.S.A.