

Nº 5805

Nº 5802

INTEGRATED AMPLIFIER OWNER'S MANUAL

mark
levinson®
by HARMAN

TABLE OF CONTENTS

Overview	2
Installation	4
Unpacking, placement and ventilation	4
Power requirements, Operating states	5
Connections	6
Rear panel overviews	6
External component connections	7
Quick Listen	11
Control	11
Front-panel overview	12
Remote control overview	13
Remote control operation	14
Browser Setup Panel	15
Setup	16
Setup navigation	16
Input setup	17
Volume setup	21
Power setup	22
Display setup	22
Advanced setup	23
SSP (surround processor integration) setup	27
Troubleshooting	29
Specifications	32

OVERVIEW

INTRODUCING THE MARK LEVINSON N°5805 AND N°5802 INTEGRATED AMPLIFIERS

Congratulations on your purchase of a Mark Levinson® integrated amplifier. You now possess one of the finest audio reproduction devices in the world, a product that will provide an exceptional music listening experience for years to come.

The N°5805 and N°5802 harness decades of superlative audio engineering and the latest advancements to deliver unmatched performance and value. With a bold industrial design, fully discrete PurePath circuitry, PrecisionLinkII DAC, MainDrive headphone power, and potent dual monaural class AB amplification, the N°5805 and N°5802 deliver luxurious fidelity with premium features and flexibility. The N°5805 features analog and digital inputs, while the N°5802 has digital inputs only. The N°5805 and N°5802 are proudly designed, engineered, and precision-crafted in the USA.

Industrial Design

Robust materials, lavish finishes and striking geometry are hallmark attributes of Mark Levinson designs. The one-inch-thick, bead-blasted, black-anodized, solid aluminum front panels are machined and contoured to flow seamlessly into the sleek glass display, which itself is recessed into a clear-anodized aluminum bezel.

The iconic Mark Levinson hourglass knobs are redefined - machined with a gently curved profile transitioning into a rounded front, with feet to match. With debossed top cover vents, screen-printed logo behind the glass panel, and aluminum buttons, no detail has been overlooked. An elegant 5000 Series custom aluminum IR remote control is included.

Digital Audio

The N°5805 and N°5802 offer outstanding digital audio capability through the Mark Levinson PrecisionLink II DAC. The latest generation ESS Sabre 32-bit D/A converter with jitter elimination circuitry and a fully balanced, discrete current-to-voltage converter form the heart of the digital audio processing stage. There are seven user selectable PCM filters and 4 low-pass filters for DSD playback.

Both models include MQA (Master Quality Authenticated) technology, which enables playback of MQA audio files and streams from any digital input (excluding asynchronous USB). In addition, a Bluetooth receiver equipped with AptX-HD for the highest quality Bluetooth playback available.

Main drive Class A headphone power

Like the acclaimed 500 series components, The N°5805 and N°5802 feature a MainDrive™ headphone output which employs a preamp output stage specifically designed with the current and power capacity to drive headphones directly in pure class A, without a separate headphone amp.

Amplification

The fully discrete, direct-coupled, class AB amplifier channels get their power from an oversized (500+ VA) toroidal transformer with individual secondary windings for the left and right channels. The voltage gain stage employs a topology directly descended from the acclaimed N°534 amplifier, which is mated to an output stage comprising two high-speed driver transistors operating in class A and six 260V, 15A output transistors. Four 10,000-microfarad capacitors per channel, located directly on the output stage circuit board, easily provide enough current for a conservative 125W/channel at 8 ohms, with significant power increase and reliable operation into 4 and 2 ohm loads. Variable line-level RCA outputs allow system expansion and flexibility.

Control

System integration and communication ports include Ethernet, RS-232, IR input, and 12V trigger input and output. An internal webpage allows setup, import and export of configurations, and software updates using a PC and standard web browser. In addition, drivers are available for major control systems.

N°5805 Analog Input Stage

The foundation of the N°5805 is its proprietary PurePath circuitry- a fully discrete, direct-coupled, dual-monaural line-level preamp circuit, for which the Shelton design team has two patents pending. A unique single gain stage mated to a digitally controlled resistor network for volume adjustment maintains maximum signal integrity and widest possible bandwidth. Each of its three stereo line level inputs—one balanced XLR and two single-ended, using custom Mark Levinson RCA connectors—has its own individual high-reliability signal switching relays.

A newly designed Phono stage features a hybrid gain topology, mating key discrete components from the acclaimed N°500 series Pure Phono stage with low-noise integrated circuits for high performance and space efficiency. Also like the N°500 series, a hybrid active/passive RIAA equalizer employs precision resistors and polypropylene capacitors for exceptional accuracy and sonic clarity. The user can select MM/MC gain and infrasonic filter from the setup menu, while capacitive and resistive loading settings are easily accessed from the rear panel.

Highlights

Digital Inputs

- 1 x USB 2.0, 1 x coaxial S/PDIF, and 2 x optical S/PDIF (N° 5805)
- 1 x USB 2.0, 2 x coaxial S/PDIF, 2 x optical S/PDIF, and 1 x AES/EBU (N° 5802)
- 384kHz/32 bit PCM and DSD 11.2MHz capability
- Bluetooth audio input including aptX-HD support
- Full MQA decoding

Analog Inputs (N° 5805 only)

- 1 x balanced XLR stereo, 2 x RCA stereo, 1 x RCA Phono (MM/MC)
- HT processor pass-thru mode

Outputs

- Line outputs: 1 x RCA stereo (variable)
- Headphone output: 1 x 1/4-inch/6.35mm jack (front panel)
- Speaker outputs: 2 pairs high-current binding posts

Control

- Control ports: Ethernet (RJ45), RS-232 (DB9), 12V trigger input/output and IR input (3.5mm jack)
- Webpage setup, configuration import/export, software updates
- Included handheld IR remote control
- Control modules for third-party automation

For the most up to date information please visit www.marklevinson.com

INSTALLATION

UNPACKING

When unpacking your N°5805 / N°5802:

- Save all packing materials in case you need to ship your integrated amp in the future.
- Inspect your integrated amp for signs of damage during shipment. If you discover damage, contact your authorized Mark Levinson® dealer for assistance in making appropriate claims.
- Locate and remove the accessories from the shipping carton. Make sure that all of the items listed below are included. If any are missing, contact your authorized Mark Levinson dealer.

1 x IEC power cord (terminated according to the region to which the unit is shipped)

1 x Remote control plus 2 x AAA batteries

1 x Owner's Manual

1 x Safety information sheet

1 x hex tool for remote

Please register your N°5805 / N°5802 within 15 days of your purchase. Register online at www.marklevinson.com. Retain your original, dated sales receipt as proof of warranty coverage.

PLACEMENT AND VENTILATION

- Install the integrated amplifier on a shelf with nothing above it, such as the top shelf in an open rack, to ensure proper ventilation. DO NOT install the integrated amplifier inside of an enclosed cabinet or rack.
- Ensure that you install the integrated amplifier on a solid, flat and level surface.
- Install the integrated amplifier as close as possible to associated audio components to keep interconnecting cables as short as possible.
- Select a dry, well-ventilated location that is out of direct sunlight.
- DO NOT expose the N°5805 / N°5802 to high temperatures, humidity, steam, smoke, dampness, or excessive dust.

POWER REQUIREMENTS

The N°5805 is configured at the factory for 100, 115, or 230 VAC power operation at 50Hz or 60Hz. Before operating the amplifier, ensure that the power label on the rear panel near the AC input connector indicates the correct operating voltage. A detachable IEC power cable intended for use in the region where the N°5805 / N°5802 is sold is included.

Connection to an AC voltage other than that for which the N°5805 / N°5802 is intended can create a safety and fire hazard and may damage the unit. If you have any questions about the voltage requirements for your N°5805 / N°5802 or about the line voltage in your area, contact your authorized Mark Levinson dealer before plugging the N°5805 / N°5802 into an AC power outlet.

WARNING! MAKE SURE all components in the audio system are properly grounded. Do NOT defeat the safety purpose of polarized or grounding-type plugs with “ground-lifter” or “cheater” adapters. Doing so may cause a dangerous voltage to build up between components, which may result in personal injuries and/or product damage.

NOTE: The N°5805 / N°5802 is capable of delivering remarkable sound at exceptional power levels. Depending on your listening preferences, the demands of your loudspeakers and the number of power amplifiers present in your system, it is possible electrical service may become the limiting performance factor in your system.

If this case occurs, consider installing a dedicated AC circuit for the system. If more than one AC circuit is providing power to your system, contact a licensed electrician to ensure that all components are operating with the same solid, low-impedance ground reference.

Unplug the N°5805 / N°5802 from the AC wall outlet during lightning storms and extended periods of non-use.

CAUTION: Before moving the unit, make sure it is powered off by removing the power cord from the AC power outlet and the unit's rear panel.

OPERATING STATES

The N°5805 / N°5802 has three operating states:

Off: The AC mains power is disconnected by removing the power cord from the rear panel.

Standby: The *Standby* mode has three settings that can be selected via the *Setup* menu: Green, Power Save, and Normal. (See page 22 for more information on changing *Standby* mode settings.)

Green: This mode removes power from almost all of the amplifier's circuits, allowing the unit to be activated only via an IR control signal, a 5V – 12V trigger or a double press of the *Standby* button. This mode provides maximum power conservation and is the factory-default *Standby* mode.

Power Save: This mode removes power from the audio circuits, but keeps the control circuitry powered and ready to receive commands from the front panel controls, or the remote control or the web-browser Graphical User Interface (GUI). This mode provides moderate power conservation.

Normal: This mode shuts off the display and mutes its audio outputs, but keeps all of its control and audio circuits powered. This mode provides the least amount of power conservation but allows the N°5805 / N°5802s audio circuits to remain warmed up to deliver optimal performance at all times.

On: The entire unit is powered up and all configured outputs are active.

The N°5805 / N°5802 has an Auto Off feature that automatically places it into the *Standby* mode after 20 minutes of no user control input or audio signal passing through the unit. The factory default setting for the Auto Off feature is On (engaged) as required for certain regions. You can disable the Auto Off feature in the *Setup* menu (see Setup on page 16).

CONNECTIONS

REAR-PANEL OVERVIEW N°5805

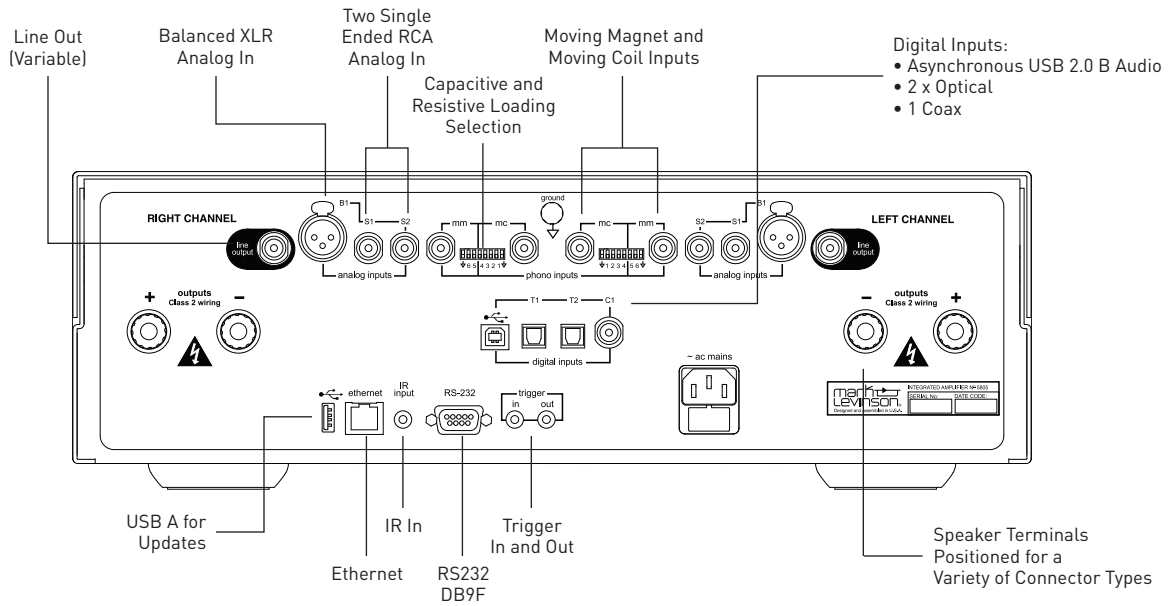

REAR-PANEL OVERVIEW N°5802

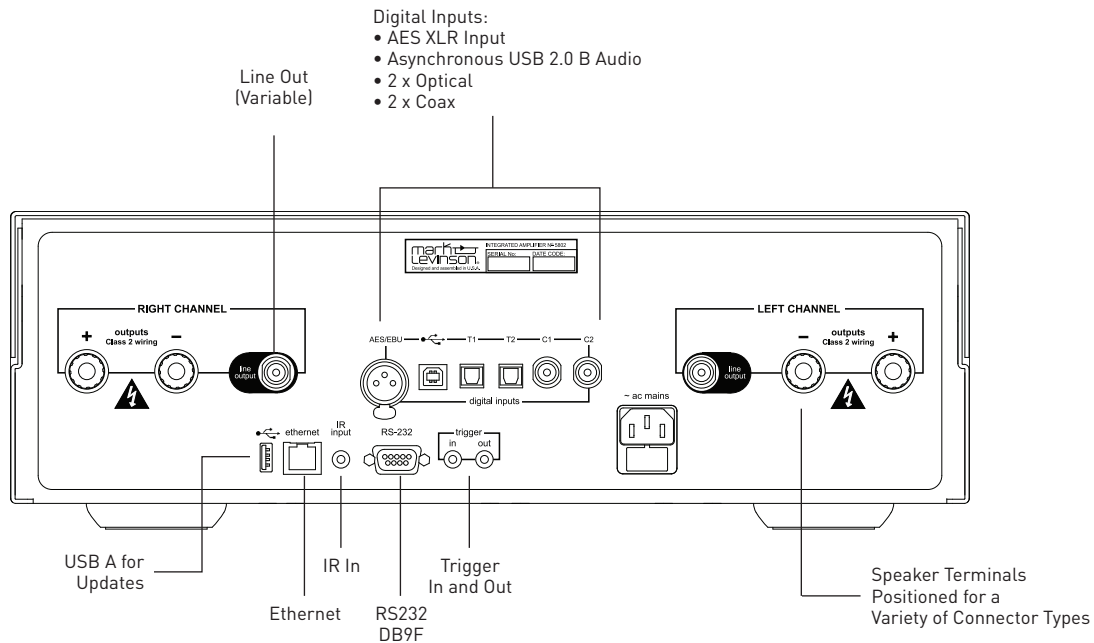

EXTERNAL COMPONENT CONNECTIONS

CAUTION: Before making connections, make sure the N°5805 / N°5802 and all associated components are powered off and disconnected from electrical outlets.

Left and right channel loudspeaker binding posts: The N°5805 / N°5802 utilizes gold-plated, high-current loudspeaker binding posts. The positive binding posts, labeled + (positive), are red; the negative binding posts are black and are labeled – (negative). The binding posts can accommodate speaker cables terminated in un-tinned bare wire, spade lugs and banana plugs.

CAUTION: DO NOT OVER TIGHTEN the binding posts. DO NOT FORCE the binding post nuts over a bent or oversized connector. Doing so may damage the binding post.

Connect your speakers to the N°5805 / N°5802's loudspeaker binding posts. Use 16-gauge or larger speaker wire to ensure the highest fidelity performance. Connect the speaker's positive (+) terminal to the N°5805's positive (+) red binding post, and the speaker's negative (-) terminal to the N°5805's negative (-) black binding post. Failure to follow correct polarity (+/+, -/-) and connecting the speakers out of phase will result in poor bass response and vague stereo imaging.

CAUTION: Be careful not to short the positive and negative outputs together. Do not short the positive or negative outputs to chassis or any other safety ground.

NOTE: The audio outputs of this power amplifier are considered Class 2 (CL2) circuits in North America. This means the wire connected between this amplifier and the speaker(s) shall be rated at minimum Class 2 (CL2) and shall be installed according to the U.S. National Electrical Code (NEC) Article 725 or Canadian Electrical Code (CEC) Section 16.

Main Drive Headphone output (front panel): Connect any headphone equipped with a 1/4" TRS "Phone" plug or adaptor. The speaker and line outputs are muted when headphones are plugged in.

Balanced analog inputs (N°5805 only): These connectors accept left-channel and right-channel balanced input signals from source components with balanced (male XLR) output connectors.

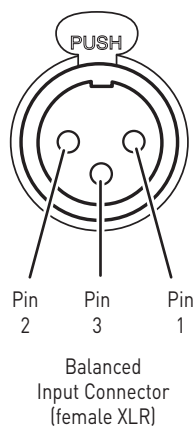

Balanced connector pin assignments:

- Pin 1: Signal ground
- Pin 2: Signal + (non-inverting)
- Pin 3: Signal – (inverting)
- Connector ground lug: Chassis ground

Single-ended analog inputs (N°5805 only): The N°5805 has two analog RCA input connectors per channel (labeled S1 and S2) that accept left-channel and right-channel single-ended input signals from source components with unbalanced RCA type output connectors.

Phono inputs (N°5805 only): The N°5805 has two analog phono preamplifier inputs per channel (labeled MM and MC) that accept left-channel and right-channel moving magnet (MM) and moving coil (MC) phono cartridge input signals.

Connect a turntable equipped with a moving magnet to the MM inputs. Connect a turntable equipped with a moving coil cartridge to the MC inputs. You may connect only one turntable to the N°5805. If the turntable is equipped with a ground wire, connect it to the ground screw.

The white DIP switches adjacent to the phono inputs set the input Resistance for moving coil cartridges and the input Capacitance for moving magnet cartridges. Selecting the right setting is essential for getting the best performance from your turntable. Consult the cartridge’s owner’s manual for the recommended load setting. Use a small tool such as a jeweler’s screwdriver to push the switches up or down as needed. The factory default is all switches in the down position. Follow the chart below to make the correct settings. Choose the setting that is closest to the specified setting. For example, if the specified MC load is 100 Ohms, use the 110 Ohm setting.

CAUTION: The volume should be set to a very low level while re-setting the DIP switches.

CAUTION: Do not use the phono inputs for any source component other than a turntable.

Loading Switches						Loading Value
Moving Coil				Moving Magnet		
1	2	3	4	5	6	
↓	↓	↓	↓	x	x	1000Ω
↓	↓	↓	↑	x	x	500Ω
↓	↓	↑	↓	x	x	250Ω
↓	↓	↑	↑	x	x	200Ω
↓	↑	↓	↓	x	x	125Ω
↓	↑	↓	↑	x	x	110Ω
↓	↑	↑	↓	x	x	90Ω
↓	↑	↑	↑	x	x	82Ω
↑	↓	↓	↓	x	x	62Ω
↑	↓	↑	↓	x	x	52Ω
↑	↑	↓	↓	x	x	43Ω
↑	↑	↑	↑	x	x	37Ω
x	x	x	x	↓	↓	20pF
x	x	x	x	↓	↑	70pF
x	x	x	x	↑	↓	120pF
x	x	x	x	↑	↑	170pF

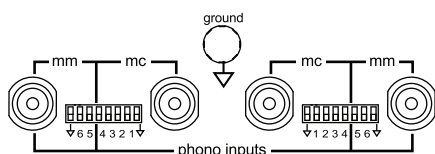

The phono inputs are balanced. Setting the ground switch ↓ to the up position references the input to ground which is sometimes useful if there is excessive noise or hum present.

Digital inputs (N°5805): The N°5805 has four digital audio input connectors: an asynchronous USB-B (labeled with a USB icon ) , two optical (TOSLINK) S/PDIF connections (labeled T1 and T2) and one coaxial (RCA) S/PDIF connections (labeled C1).

Digital inputs (N°5802): The N°5802 has six digital audio input connectors: An AES/EBU-format XLR connection (labeled AES/EBU), an asynchronous USB-B digital audio connector (labeled with a USB icon ) , two optical (TOSLINK) S/PDIF connectors (labeled T1 and T2), and two coaxial (RCA) S/PDIF connectors (labeled C1 and C2).

USB port: This USB Type-A connector allows you to perform firmware upgrades that may be offered in the future, and to import and export setup configurations via a standard USB drive or memory stick (FAT32 formatted). Firmware updates may also be accomplished via download when the unit is connected to a local area network (LAN) via an Ethernet cable. (See page 24 for more detailed firmware update instructions.)

Bluetooth: Bluetooth-enabled smart devices may be paired with the N°5805 / N°5802 to stream audio content wirelessly. Integrated Qualcomm® aptX™-HD audio ensures your Bluetooth® wireless enabled device can deliver High Definition (HD) audio. (See Setup on page 19 for Bluetooth pairing instructions.)

Line output connectors: These RCA jacks provide a line-level left-channel and right-channel signal that can be used to send the selected input to an amplifier connected to speakers in a second listening zone, or a recording device.

Note: The Line outputs are variable and will follow the settings of the Volume, Balance and Mute controls.

Ethernet port: This RJ45 jack supports connection to a home network via Cat5e or CAT6 Ethernet cable and allows you to access the *Setup* menu and other controls via a browser-based setup panel.

IR input connector: This connector accepts IR (infrared) control signals from other equipment. See www.marklevinson.com for IR code data.

RS-232 port: This DB9F connector provides serial control through a standard RS-232 protocol. See www.marklevinson.com for RS232 code data.

Trigger output connector: This 3.5mm tip/sleeve connector can be used to activate other components in the audio system and listening room, such as amplifiers, lights and window shades. A 12V 100mA DC signal is output whenever the N°5805 / N°5802 is on. (See illustration below.)



Trigger input connector: This 3.5mm tip/sleeve connector can be connected to the trigger output of another system component or control system that supplies a trigger voltage. Whenever the units detects a voltage between 5V and 12V DC at this connection it will turn ON. When the trigger signal at this connection ceases the N°5805 / N°5802 will enter the *Standby* mode. (See illustration above.)

AC Mains connector: This connector provides AC power to the N°5805 / N°5802 when the supplied power cord is connected from it to an AC electrical outlet. This should be the LAST connection you make in the hookup process.

We recommend that you unplug the unit from the AC wall outlet during lightning storms and extended periods of non-use.

NOTE: After connecting all source components to the N°5805 / N°5802, we suggest using the *Setup* menu to set the names of all unused inputs to "Disable." This will remove the unused inputs from the list of available inputs and skip over them when scrolling through inputs. (See Setup/Input on page 18 for more information.)

CONNECTIONS

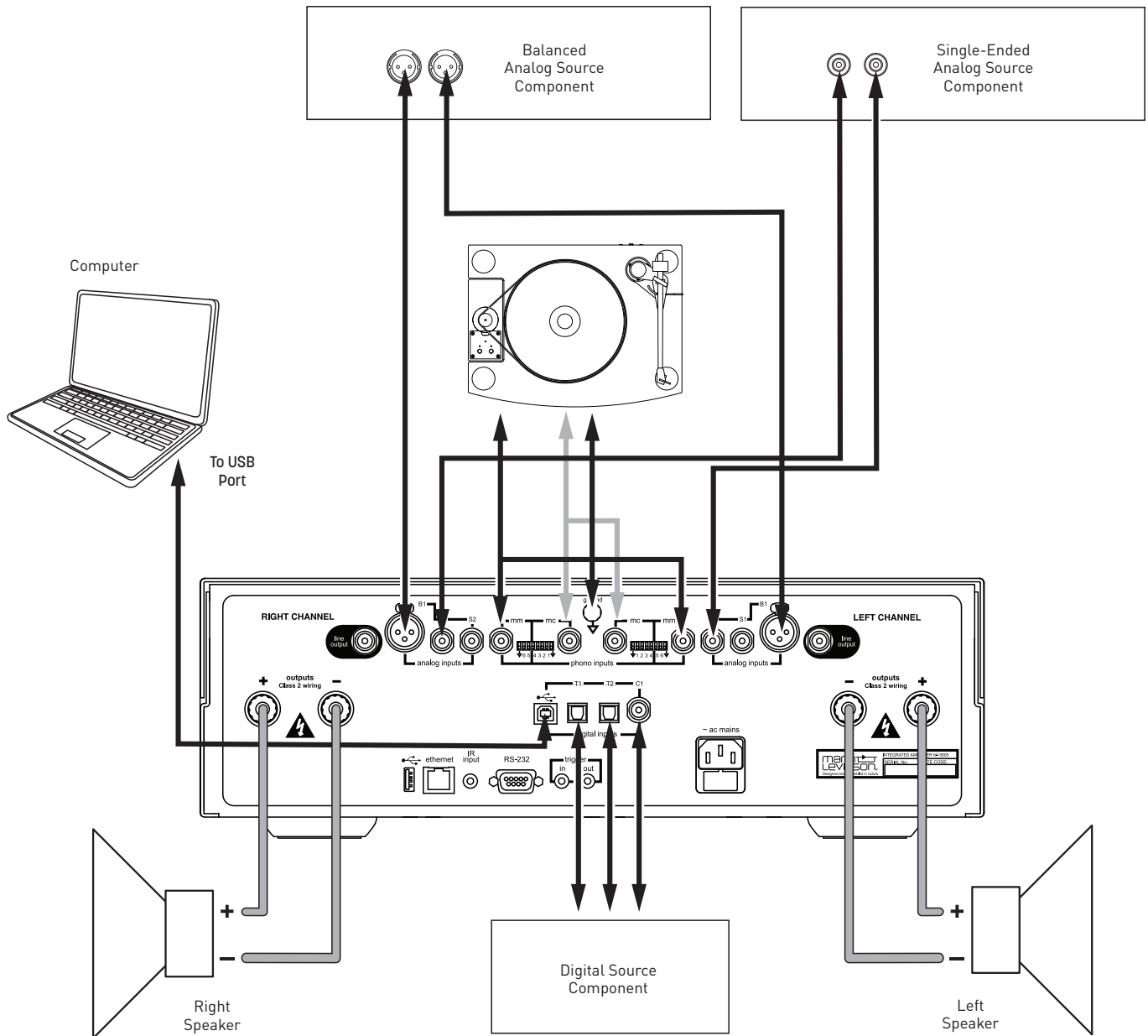

QUICK LISTEN

1. Connect the supplied power cable to the N°5805 / N°5802's AC Mains connector and an electrical outlet. Power on the N°5805 / N°5802 and all source components.
2. Press the *Standby* button on the N°5805 / N°5802's front panel or remote control to turn it on.
3. Rotate the N°5805 / N°5802's input select knob or press the Select +/- buttons on the remote to select the input for the source component you want to hear.
4. Make sure the N°5805 / N°5802's volume is set to a reasonable level (30 is a good starting point).
5. Begin playing the selected source device.
6. Sit back, relax and delight in the incredible realism of your Mark Levinson high-performance audio system.
7. For more information on how to get the best performance and convenience from your new amplifier, read on. You will be glad you did.

CONTROL

The N°5805 / N°5802 is highly flexible and allows a variety of means of setup and control including front panel control knobs, IR remote and integration with 3rd party control systems. Additionally, an internal webpage allows setup, import and export of configurations, and firmware updates using a PC or tablet and a standard web browser.

FRONT-PANEL OVERVIEW

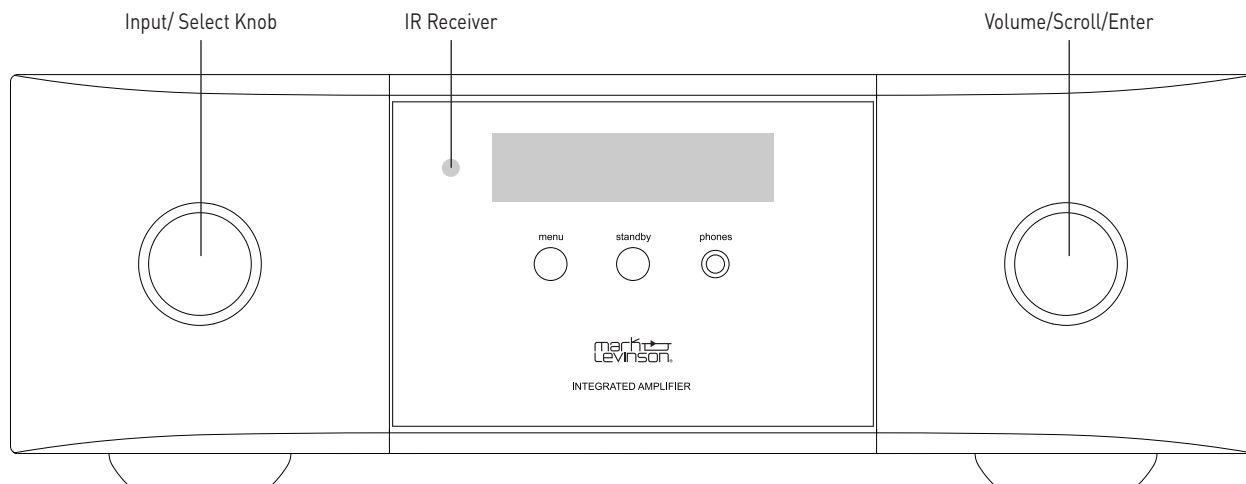

The N°5805 / N°5802 was designed for elegant simplicity and ergonomics. Therefore the knobs perform a variety of functions depending on the operating mode. There are two modes of operation, Listening mode and Setup mode, and three modes of standby, Green, Power-save, and Normal.

Please read this section carefully and take the time to learn the operating modes. We strongly recommended you turn your volume very low or all the way down before entering the setup mode.

Standby button and LED: Press this button to put the N°5805 / N°5802 into and out of the *Standby* mode. The LED illuminates steady RED when the unit is On. When the unit is in the standby state, the LED flashes slowly.

Input/Select knob: When in listening mode rotate this knob to select the desired source signal to send to all outputs. The front panel display indicates the name and volume level of the selected input. (Note: The Select knob will bypass any input for which the Input Name parameter is set to "Disabled" in the setup mode.) When in setup mode, turning this knob will scroll through menu choices.

IR receiver: The IR receiver receives commands from the included remote control when the rear-panel IR Input is not being used.

Menu button: Press this button to display the *Setup* menu, which you can use to customize the N°5805 / N°5802 to suit your other system components and individual preferences. This button performs a "Back" function when more than two levels deep into menu parameters.

Headphone output: Connect any headphone equipped with a 1/4" tip/ring/sleeve "Phone" plug or adaptor. When headphones are plugged in the speaker and line outputs are muted.

Volume/Scroll/Enter: This knob is a rotary encoder and switch. When in listening mode, this knob acts as a volume control. Turn this knob to adjust the volume level. When the setup mode is activated by pressing the *Menu* button, this knob/button scrolls through the setting options and acts to select or deselect the displayed choice when pushed inward. The Enter button displays the sampling rate for digital inputs when in listening mode. If "MQA" or "MQA." is displayed along with the sampling rate, it indicates that the product is decoding and playing an MQA stream or file. "MQA." indicates it is playing an MQA Studio file, which has either been approved in the studio by the artist/producer or has been verified by the copyright owner.

Front Panel Display: This 32-character alphanumeric display provides information about the N°5805 / N°5802's operating status. During normal operation, it indicates the name and volume level of the selected input.

REMOTE CONTROL

REMOTE CONTROL OVERVIEW

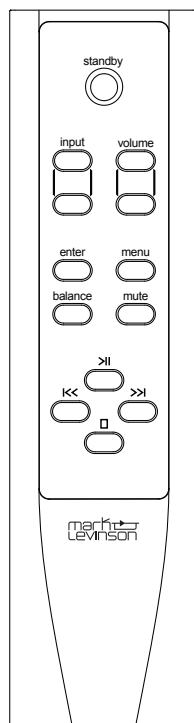

Standby: Press this button to put the N°5805/ N°5802 into and out of the *Standby* mode. Press this button twice to wake up unit from green *Standby* mode.

Input +/-: Press these buttons to select the desired input. Allow a moment for the relays to switch. The name and volume level of the navigate to input is indicated on the front-panel display. These buttons are also used to select functions in the Setup mode (see page 16).

Volume +/- buttons: Press these to adjust the volume level of the speaker, line, and headphone outputs. The minimum volume level is 0; the default maximum volume level is 80, but you can change that value in the *Setup: Volume* menu (see page 21).

Menu: Press this button to display the *Setup* menu, which you can use to customize the N°5805 / N°5802 to suit your system and preferences. The word "Setup" appears on the front panel display when the *Setup* menu is active. This button performs a "Back" function when more than two levels deep into menu parameters.

Mute: Press this button to mute and unmute the speaker, line and headphone outputs by the amount determined in the *Setup* menu (the default value is -40dB). The word "Mute" appears on the front panel display when the mute function is engaged.

Enter: Press this button to select or deselect a menu item when in the Setup mode.

Balance: Press this button to set the left-to-right channel balance. The symbols < - - L/R - - > appear in the front panel display. To change balance use the Volume + button to shift channel balance to the right in 1 dB steps. Use the Volume - button to shift channel balance to the left. Maximum shift is -20dB, followed by the reverse channel turning off.

While in Balance mode other controls will not operate. To exit the Balance mode, push the Balance button a second time.

Bluetooth Transport control: When using a Bluetooth source these buttons control navigation of the program material when used with compatible Apps.

REMOTE CONTROL OPERATION

Battery Installation

Your N°5805 / N°5802 remote control comes with two AAA alkaline batteries. To install the batteries, use the included hex tool to remove the battery cover, insert the batteries and replace the battery cover and hex screw. Be sure to observe proper battery polarity.

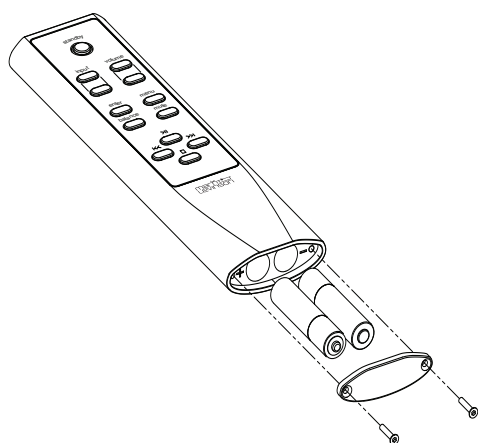

Using the Remote Control

When using the remote control, aim it toward the unit's front panel IR receiver. Make sure that no objects, such as furniture, block the remote's view of the receiver. Bright lights, fluorescent lights, and plasma video displays may interfere with the function of the remote.

- The remote has a range of about 17 feet (5m), depending on the lighting conditions.
- You can use the remote at an angle of up to 45° on either side of the unit.
- Placing the amplifier behind tinted glass will reduce the remote control's effective range.

If the remote control operates intermittently, replace both batteries with new ones.

BROWSER SETUP PAGE (BSP)

The BSP is a highly convenient means of keeping the firmware of your amplifier up to date, for performing setup functions, and monitoring operational faults and temperature. It is accessed via a major web browser on a PC or tablet. In order to access the BSP, you must first connect the unit to your Local Area Network (LAN). If there is no easy access to a LAN there are other means of setup and control, discussed elsewhere in this manual.

- Connect the Ethernet port on the rear panel of the N°5805 / N°5802 to an ethernet port on your home network's router, switch or hub with a Category 5e or Category 6 Ethernet cable.
- **Find the IP address of your unit by navigating through the Setup menu to Advanced/Network/IP.**
- Open a browser in a PC or tablet that is connected to your home LAN.
- Enter the IP address of your unit in the address line.
- The amplifier's Browser Setup Panel Home page will appear on the screen.

- The BSP controls are intuitive and behave much like the front panel and remote controls.

NOTE: We do not recommend using the BSP as a substitute for the front panel or remote controls for real-time volume, input selection or any other listening mode functions due to network latencies.

NOTE: The front panel display is replicated on the top of *Home* and *Advanced* Update pages

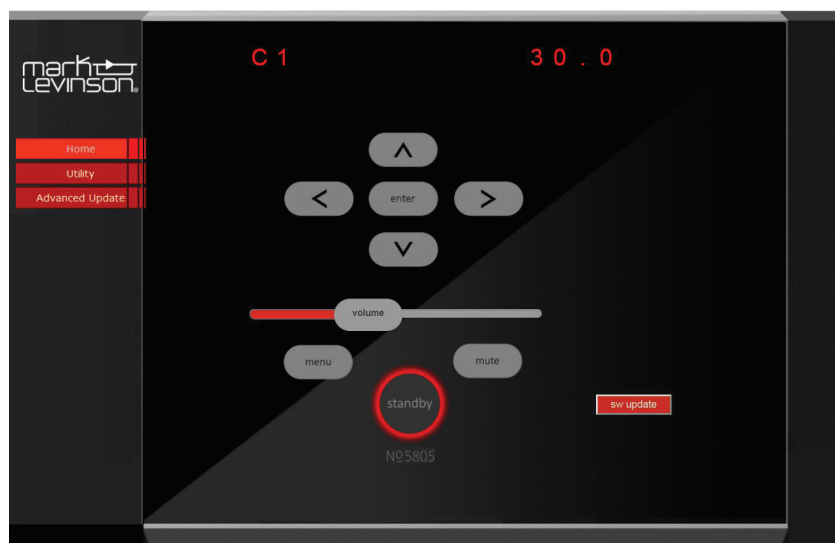

SETUP

SETUP MENU NAVIGATION

The *Setup* menus on your Mark Levinson integrated amplifier allow you to customize and configure the unit for higher performance, power economy, and convenience.

There are two means for accessing and navigating the *Setup* menu: via the front panel display using the front panel or remote control, or via the Browser Setup Page on a networked browser-enabled device. Regardless of the method you choose, the procedures are similar.

Remote and Front Panel Operation

Press the *Menu* button to display the *Setup* menu on the integrated amplifier's front-panel display. When the *Setup* menu is active, use the Select knob to scroll through options, the *Select Knob* on the front panel or *Enter* button on the remote to select and deselect options, and the *Volume* knob to adjust parameters. To move back a level in the menu structure (or exit the *Setup* menu), press the *Menu* button repeatedly until the desired menu appears in the display.

Browser Setup Page (BSP) Operation

Connect your Mark Levinson integrated amplifier to a PC or tablet via your home network and open a browser. Simply type in your unit's IP address into a major browser connected to the same network as the N°5805 / N°5802, and the BSP will appear in a few moments. Network speed and quality of the connection will affect the response time of the BSP (see page 15 for instructions on finding the IP address on your N°5805 / N°5802). The *Home* screen displays the current active input name near the top of the screen, the current volume level in the slider and navigation controls. In addition there is a SW update button which provides a one touch update from our FTP site. **CAUTION: If you choose to update the SW, DO NOT interrupt the process.**

Click the *Menu* icon to activate the setup mode. When the *Setup* menu is active, use the Left < and Right > arrows to scroll through options, use the *Enter* icon to select and deselect options, and the up ^ and down v arrows to adjust parameters. To move back a level in the menu structure (or exit the *Setup* menu), click the *Menu* button repeatedly until the desired menu appears in the display.

INPUT SETUP (5805)

Setup Menu	Input Setup
Input	B1 [analog XLR]
Volume	S1 (analog RCA)
Power	S2 (analog RCA)
Display	Phono (analog)
Advanced	C1 (digital coaxial)
	T1 (digital optical)
	T2 (digital optical)
	USB
	BT (Bluetooth)

Set Input X	
Name=XXX	Available for all inputs
Offset=XXX	
SSP=On/Off	Available for analog inputs
PCM Filter=XXX	Available for digital and Bluetooth inputs only
PLL Lock= Normal/Wide	
Upsample=On/Off	
DSD Filter= XXX	Available for USB input
BT Name	Available for Bluetooth input only
BT Pairing= Enable/Forget	
Ph Balance= +/- 3dB	Available for phono input only
Infra Filt = On/Off	
Phono Type= MM/MC	

INPUT SETUP (5802)

Setup Menu	Input Setup
Input	AES [Digital XLR]
Volume	C1 (digital coaxial)
Power	C2 (digital coaxial)
Display	T2 (digital optical)
Advanced	T2 (digital optical)
	USB
	BT (Bluetooth)

Set Input X	
Name=XXX	Available for all inputs
Offset=XXX	
PCM Filter=XXX	
PLL Lock= Normal/Wide	
Upsample=On/Off	
DSD Filter= XXX	Available for USB input
BT Name	Available for Bluetooth input only
BT Pairing= Enable/Forget	

The following settings are available for all inputs:

Name: This option offers a choice of preset names for the selected input (CD, SACD™, DVD, Blu-ray™, DAC, EQ, etc.). Additionally, the following names are available for each input:

Disabled: This option removes the selected Input from the list of available inputs. The Input will be skipped when scrolling through the inputs.

Custom: This option allows you to enter a custom name for the selected input. Use the Select knob to select the character you want to change, use the Volume control to choose from the list of available characters and press the Enter button to confirm each character. After the ninth character is entered, the new name will be saved.

Browser Setup Page method:

The easiest way to change input name is to select the *Utility* tab on the BSP.

Select the input you want to rename from the first drop-down menu. These correspond with the labeled inputs on the rear panel.

Select an alternate name (or *Disable*, or *Custom*) from the next drop down menu and push OK to save.

If you selected *Custom*, you can type the custom name in the text box and press OK to save.

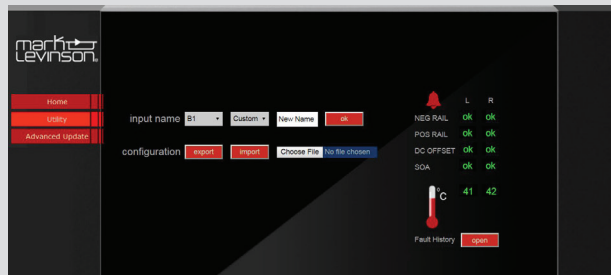
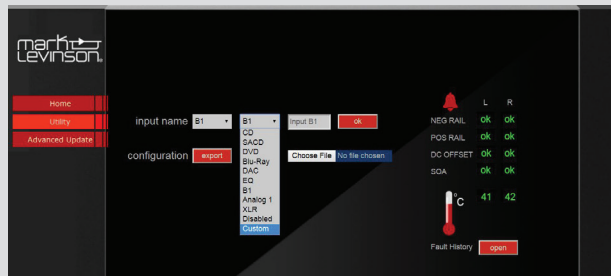
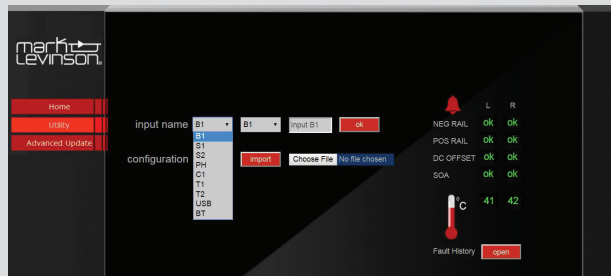
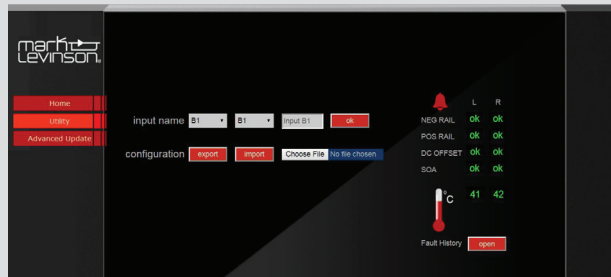

Offset: The output level of audio devices can vary from brand-to-brand and model-to-model, making some devices play louder or quieter than others. The Offset adjustment allows you precisely compensate for source volume differences so that all connected devices play at a similar volume level. The setting offers a range of -12.0dB to +12.0dB, in 0.5 dB steps.

The following settings are available only for digital and Bluetooth inputs:

PCM Filter: This setting lets you set the filter characteristic for PCM digital content such as the digital output from a CD player. We recommend trying several of these filters with the types of music you typically listen to and choose the one you prefer. There are no right or wrong choices.

The available filters are:

- Apodiz Fast
- Hybrid fast
- Brickwall
- Fast linear
- Slow linear
- Slow minimum
- Fast minimum

“Fast” filters provide steeper roll-off at high frequencies and therefore do a better job of attenuating unwanted high frequency “aliased” signals. However, they exhibit more ringing on signal transients.

“Slow” filters exhibit less ringing on transients, but they do a poorer job of attenuating unwanted high frequency signals.

“Linear Phase” filters exhibit symmetric pre- and post-ringing, i.e., they ring before and after the transient signal.

“Minimum Phase” filters exhibit only post-ringing, which some listeners feel sounds more natural, but they typically ring for longer than linear phase filters.

The “Hybrid” filter blends some linear phase and some minimum phase characteristics to achieve good high frequency attenuation with reduced pre-ringing.

The “Apodizing” filter blends linear phase characteristics with techniques to reduce pre and post-ringing.

The “Brick Wall” filter is optimized purely for attenuating unwanted high frequency aliased signals.

The following setting is available only for analog inputs B1, S1, S2 (N^o5805 only):

SSP: This setting configures the selected analog input for integration with a multichannel surround sound processor. The Default setting is “Off”. Selecting “On” will pass the signal though the outputs at unity gain and disable volume control. (See SSP Setup on page 28 for more information.)

PLL Lock:

Normal – This is the default setting and is appropriate for almost all sources.

Wide – Choose this setting if you experience noise or signal dropouts (most likely from high jitter sources such as cable TV set-top boxes).

Upsample On/OFF:

“Up-sampling” is the process of increasing the effective sampling rate of a digital audio signal. When the user selects this option in the N^o5805/ N^o5802, signals at 44.1, 88.2, or 176.4kHz are up-sampled to 352.8kHz, and signals at 48, 96, and 192kHz are up-sampled to 384kHz. Because these lower resolution signals inherently have fewer samples per second, it is in theory not possible to perfectly re-create the additional samples that would have been present in a higher resolution signal. However, the advanced up-sampling algorithm in the N^o5805 / N^o5802 is able to approximate these additional data points very well, and with most program material it offers a noticeable subjective improvement. Just like the user’s choice of digital filter, it is neither “right” nor “wrong” to enable or disable up-sampling; it is entirely a matter of preference.

Selecting “Off” will maintain the original sample rate.

BT Pairing:

Set to Enable and press *Enter* to start pairing. Start pairing procedure on your Bluetooth device. The name ML580X followed by a 4 digit identifier unique to each unit should appear on your device. Select this to complete pairing.

Set to *Forget* to unpair and forget your device.

BT Name:

This displays the Bluetooth Name that will appear on your Bluetooth player device when scanning to pair. This name cannot be changed.

The following setting is available only for the asynchronous USB input:

DSD Filter: This setting lets you set the low-pass filter characteristic for DSD high-resolution digital content. You can select from roll-offs that begin at 47kHz, 50kHz, 60kHz or 70kHz. The audible effects of the different roll-off characteristics are subtle and will vary depending on the type of musical content and the high-frequency bandwidth of your speakers and headphones. Feel free to experiment to find the DSD filter setting that sounds best to you.

The following settings are available only for the Phono input of the N°5805:

Cartridge Type: Select either moving magnet (MM) or moving coil (MC) cartridge.

Infrasonic Filter: This option sets the infrasonic “rumble” filter on or off.

Balance: This option applies balance adjustment to the Phono input from -3dB to +3dB in 0.5 dB steps.

NOTE: After connecting all source components to the N°5805 / N°5802, we suggest using the *Setup* menu to set the names of all inputs that are not being used to “Disabled.” This action will remove the unused inputs from the list of available inputs, thereby making source selection faster and more convenient.

VOLUME

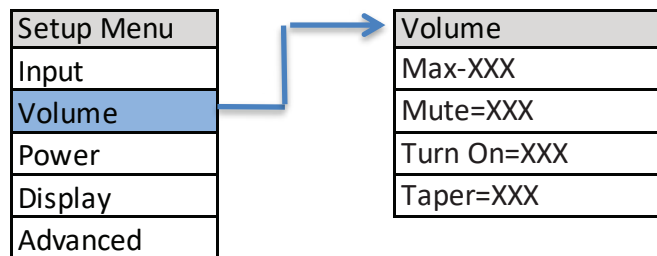

The Volume settings let you customize the action of the N°5805 / N°5802 Volume and Mute functions.

Max Vol: This setting determines the maximum volume level setting in 0.5dB increments between 40.0dB and 80.0dB. The factory default maximum volume is 80.0dB. Set this value to the volume slightly below where your speakers start to distort audibly.

Mute: This setting lets you set the amount of Speaker output and Line output level attenuation that occurs when the Mute button is engaged, in 0.5dB increments between -10dB and -80.0dB. The factory default mute attenuation is -40dB.

Turn On: This control lets you set the initial volume upon turn-on. Choose a turn-on volume level in 0.5dB increments between 10.0dB and 60.0dB. The factory default setting is 40.0dB.

Last: When selected, sets the turn-on volume level to the last used volume setting.

CAUTION: Setting the Turn On parameter to “Last” can result in louder-than-expected power-up volume if the N°5805 / N°5802 was set to a high volume level setting when last powered down.

Taper: This setting lets you choose the desired taper for the volume control from the following options:

Mode 1: The faster you rotate the volume knob, the more quickly the volume will change. Slowly turning the knob slows the rate the volume changes, allowing you to make precise adjustments in the listening level.

Mode 2: Similar to Mode 1, with a “faster” response curve, with more gain change for a similar range of knob travel.

Mode 3: When increasing the volume the volume changes quickly through the low volume range, and then decelerate in the higher range, for precision adjustments. When decreasing the volume the control works oppositely, changing quickly through the high volume range and decelerating in the lower range.

POWER

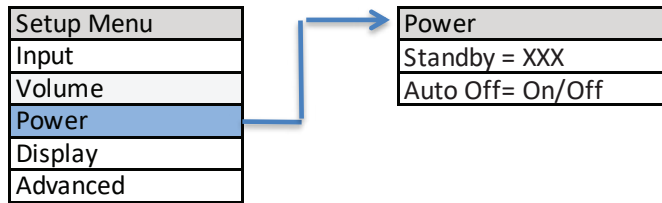

The Power parameters let you customize power-related functions.

Standby: This setting lets you set the *Standby* mode to one of the following options:

Green: This mode removes power from almost all of the N°5805 / N°5802's circuits, allowing the unit to be activated only via an IR control signal, a 5V – 12V trigger voltage or a press of the *Standby* button. This mode provides maximum power conservation and is the factory-default *Standby* mode.

Power Save: This mode removes power from the N°5805 / N°5802's audio circuits but keeps the control circuitry powered and ready to receive commands from any of the control inputs. This mode provides moderate power conservation.

Normal: This mode shuts off the unit's display and mutes its audio outputs, but keeps all of its control and audio circuits powered. This mode provides the least amount of power conservation but allows the audio circuits to remain warmed up to deliver optimal performance at all times.

Auto Off: This setting lets you engage or disengage the Auto Off function, which puts your N°5805 / N°5802 into the *Standby* mode after 20 minutes of inactivity (no audio signal, and no user- control input).

DISPLAY

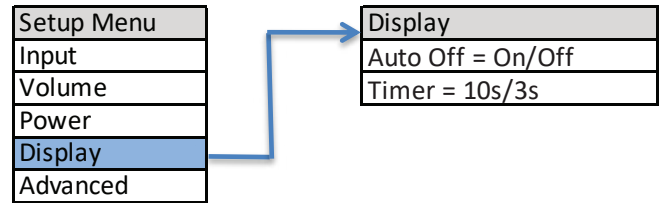

The Display function allows you to choose whether the front panel display stays on all the time, or turns off after a selectable amount of time.

Auto Off: When set to Off, the display remains lit as long as the unit is in listening mode. When set to On, the display will turn off after 3, 5 or 10 seconds.

Timer: The timer determines when the display turns off, after 3, 5, or 10 seconds.

ADVANCED

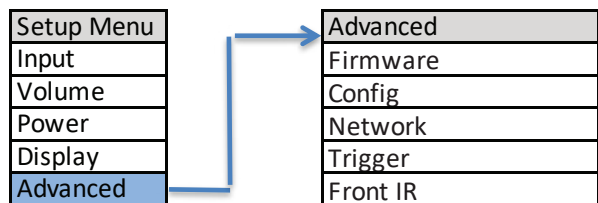

The Advanced section of the *Setup* menu gives you access to a range of configuration and administrative settings and functions.

Firmware: This menu gives you access to the following firmware-related functions:

Version: Push *Enter* to display the version number of the currently loaded firmware. Pushing *Enter* a second time will show the date of the version, and then automatically scroll and display the versions of the individual components of the update package. (This setting is informational only, and does not provide any user adjustments.)

To check if your unit's Firmware is up to date, go to the N°5805 / N°5802 product page on www.MarkLevinson.com, select the Downloads tab and look for the latest Firmware update file. If there is a later version, you may use either of the options described below to update your unit. If your unit's Firmware version is the same as the one displayed on the website, no further action is required.

Browser Set Up Page method:

Select the *Advanced Update* tab on the Browser Setup Page, and push the *Go FTP Site* button near the bottom of the page to view a list of available downloads. Click each of the txt files to see the version number of each type of software.

No5805 DOWNLOADS		
Filename	Description	Download
No5805.s19	Control board firmware image file	No5805.s19
version.txt	Control board firmware information file	version.txt
No5805cpld.jbc	No5805 CPLD firmware image file	No5805cpld.jbc
No5805cpld.txt	No5805 CPLD firmware information file	No5805cpld.txt
No5805web.bin	No5805 web pages image file	No5805web.bin
No5805web.txt	No5805 web pages information file	No5805web.txt

Update: Lets you update your N°5805 / N°5802's firmware, either from a drive inserted in the rear-panel USB port or via a web browser. (For browser connection guidance see Browser Setup Page (BSP) on page 25.)

ENET: Select this if your N°5805 / N°5802 is connected to a home network. The unit will access the Mark Levinson server and download the latest firmware. The download and installation **process takes at least 15 minutes** and should not be interrupted. The unit will cycle through several stages of downloading and installing new operating files and go in and out of *Standby* mode. BE PATIENT. You will know when the process is almost over when you see "Booting..." followed by "Starting N°5805..." followed by "Firmware Version [number]..." followed by "Starting.." The unit will then enter *Standby* mode. Wait for the *Standby* LED to start blinking before attempting to turn on the unit. BE PATIENT.

(If you select ENET when the unit is not connected to a network the unit's display shows "Failed" to remind you to connect to a network and begin downloading the firmware.)

To update via a flash drive:

1. Download the firmware file from the product page at MarkLevinson.com and save it to a USB drive
2. Select USB and press Enter
3. The N°5805 / N°5802 will read the USB drive. (The display will show "Check Update" while the drive is being read.)
4. When the N°5805 / N°5802 finds a valid firmware file on the drive, the display will show "Downloading."
 - If the N°5805 / N°5802 does not find a valid firmware file on the drive, the display will show "Not Available."

The installation **process takes at least 15 minutes and should not be interrupted.** The unit will cycle through several stages of downloading and installing new operating files and go in and out of *Standby* mode. BE PATIENT. You will know when the process is almost over when you see "Booting..." followed by "Starting N°5805 (or N°5802)..." followed by "Firmware Version [number]..." followed by "Starting.." The unit will then enter *Standby* mode. Wait for the *Standby* LED to start blinking before attempting to turn on the unit. BE PATIENT.

Browser method:

Make sure your unit is connected to a network with Internet access. Select the *Home* tab on the screen. Click the Software Update tab. You will be prompted for confirmation. Push OK and the unit will begin the update sequence. Please be patient and **DO NOT INTERRUPT**. This can take up to 15 minutes. The unit will return to *Standby Mode* when complete. Click Cancel to go back to the home page.

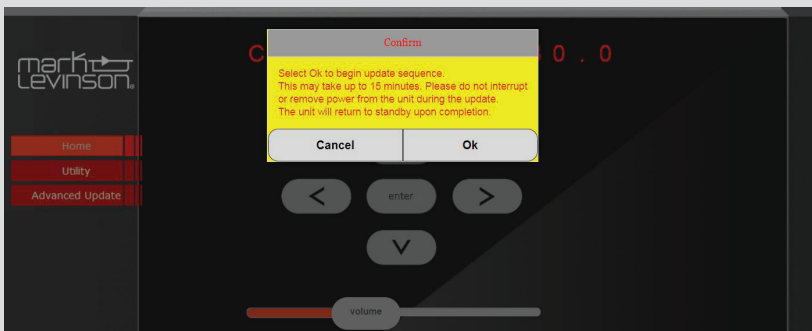
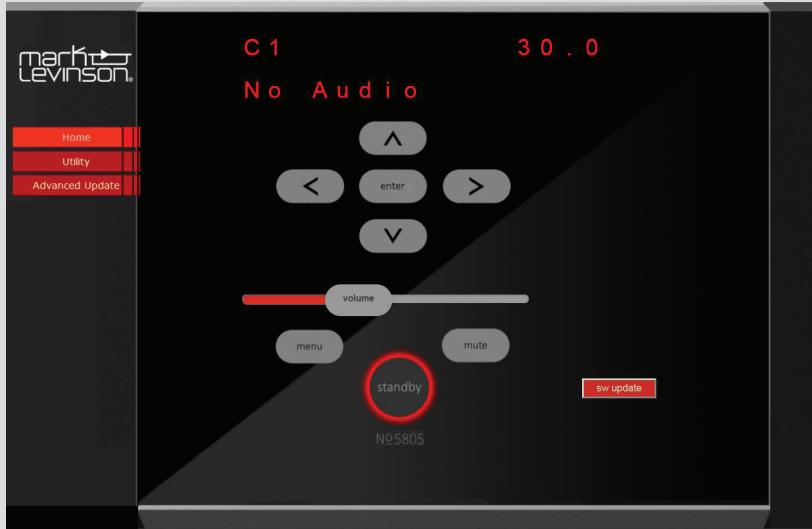

Advanced Update:

The *Advanced Update* page functions are used for uploading individual software files from the FTP server, a USB drive or your PC's hard drive. It is highly unlikely an end user will need to use this page. This page should be accessed by trained installers or service professionals.

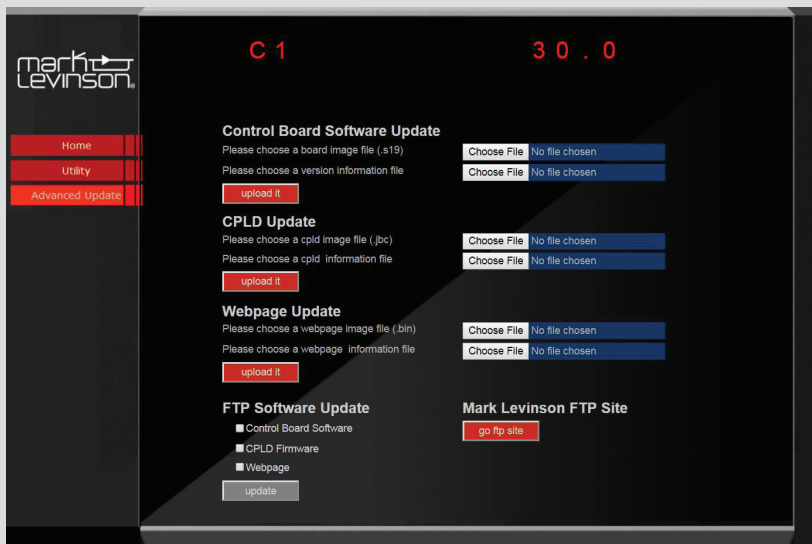

Config: This menu group allows you to lock, restore, import, or export Setup configuration settings.

Config Export: Press Enter to export all setup configuration information to a thumb drive inserted in the rear panel USB port. This data can then be used to configure other N°5805 / N°5802 units or serve as a backup so you can quickly reconfigure your unit. Once you have your unit's configuration precisely as you would like it, we strongly recommend you save a Config Export file to a thumb drive in case an untoward event erases your configuration settings.

Config Import: Press Enter to import all setup configuration information from a thumb drive inserted in the rear-panel USB port.

Config Lock: Engage the Lock to prevent accidentally changing the Setup parameters. The factory default setting is Off.

Config Restore: Restores all N°5805 / N°5802 parameters to their factory-default conditions.

Network: This menu offers access to the following network-related parameters. They are useful only if you want to connect your unit to a network to access controls and setup functions via PC or tablet.

Name: Displays your N°5805's network name in this format N5805XXXX (the X's represent the last four characters of the unit's unique MAC address). Use the input select control to select the character you want to change, and the volume control to scroll through available characters.

Current Gateway: Displays the Gateway IP address. This setting is informational only and does not provide any user adjustments.

DHCP: Lets you toggle DHCP mode (network auto-configuration) On or Off. The factory default behavior is On. When the mode is set to Off, you can specify static IP and Subnet addresses for your N°5805 / N°5802. Selecting Renew (available only when DHCP is set to On) refreshes your DHCP configuration, assigning a new IP address to your N°5805 / N°5802. This function is often useful when troubleshooting a network connection.

Current IP: Shows the IP address currently assigned at the factory (or by DHCP or manually) to your N°5805 / N°5802. Enter this number in the address (URL) line of a browser connected to the Internet. (This setting is informational only and does not provide any user adjustments.)

Current Subnet: Shows the subnet address currently assigned (by DHCP or manually) to your N°5805 / N°5802. (This setting is informational only and does not provide any user adjustments.)

Trigger: This setting configures the 12V trigger. NOTE: Using a trigger input overrides the *Standby* button.

Mode: These choices determine how the 12V trigger signals are sent and received.

Normal: The default setting, appropriate for most other components.

Pulsed: Some products (such as some older Mark Levinson components) require a pulsed trigger signal.

Theater: Turns on the N°5805 and automatically selects the input configured for SSP mode.

Off: Disables the Trigger In/Out connections.

Delay: This setting determines the amount of time after fully exiting the *Standby* mode that the unit waits to pass a trigger signal to the trigger output jack. The choices are 0 - 10 seconds, with 0 being the default. NOTE: as it can take a few seconds for the N°5805 / N°5802 to enter and exit *Standby* mode, the net trigger delay time will be longer than the value you select.

Front IR: This menu allows you to turn the N°5805 / N°5802's front IR receiver on or off. If you plan to use the rear-panel IR input, you must set the front IR receiver to Off. If you use a 3rd party control via IP or RS232, and do not plan to use IR for control, we recommend you turn the IR control to Off.

Amplifier Enable: Selecting Off turns off the amplifier section of the unit so that it will operate solely as a preamplifier or headphone amplifier. The default value is On.

SURROUND SOUND PROCESSOR (SSP) SETUP

(Applies only to the N°5805)

The SSP (Surround Sound Processor) mode allows the N°5805 to be seamlessly integrated into a multichannel home cinema system. Any analog input may be designated as the surround sound processor input by turning this mode ON. When the SSP mode is activated the N°5805's volume control is deactivated and the level is fixed at unity gain. This allows the Surround Sound Processor to control the volume of the Left and Right speakers powered by the N°5805 in unison with the rest of the system. Room correction EQ and level calibrations performed in this mode and stored in the surround sound processor will be maintained unaltered.

CAUTION: Prior to entering SSP mode make sure the volume of your surround sound processor is all the way down. Gradually increase volume as desired and perform calibration.

To start, enter the Setup mode and navigate to the analog input you plan to use for SSP and select On. Connect the N°5805 with a surround-sound processor (see illustration on next page).

1. Make sure the N°5805 and all associated components are powered off and disconnected from electrical outlets.
2. Connect the output connectors on the surround-sound source component to the input connectors on the surround-sound processor. For example, if the source component is a Blu-ray disc player, connect it to the appropriate input connectors on the surround sound processor.
3. Connect the front left and right output connectors on the processor to the desired analog input connectors on the N°5805. For best performance, use balanced connections whenever possible. NOTE: we recommend renaming the input you select for SSP operation to a name like "Theater" or "Movies."
4. Connect the center, surround, and subwoofer output connectors on the processor to the appropriate input connectors on the designated power amplifier(s).
5. Connect the N°5805's speaker outputs to the system's front left and right (primary) speakers.
6. Perform a system calibration as per the surround processor's instructions.
7. Select the designated Analog input whenever you wish to listen to multichannel source material.

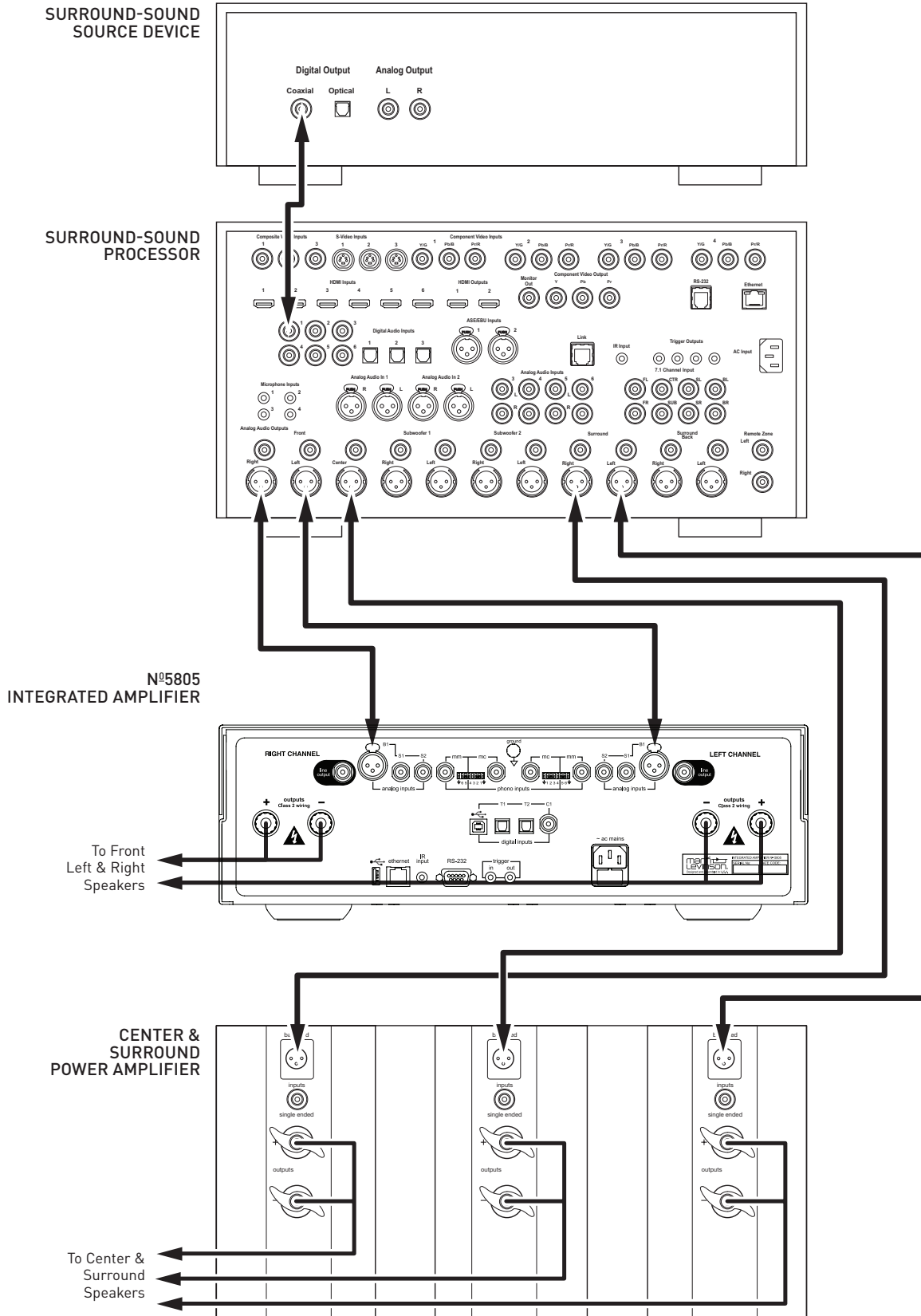

TROUBLESHOOTING

PROTECTION CIRCUIT FAULTS

If the N°5805 / N°5802 encounters a potentially damaging condition, its built-in protection circuitry will shut off the amplifier, and its Front-Panel Display will show one of the error messages listed below. Follow the instructions in the *Solution* column to correct the condition before attempting to use the N°5805 / N°5802 again.

ERROR MESSAGE	PROBLEM	SOLUTION
WARNING: DC DETECTED ON [LEFT/ RIGHT] CHANNEL	The indicated amplifier channel has detected DC on the output, which can damage speakers.	Disconnect the AC power cord from the mains power source. Wait 10 seconds and reattach the power cord. If the error message does not clear call your Mark Levinson dealer or Mark Levinson customer service.
WARNING: OVER TEMP [LEFT/ RIGHT]	Indicates the amplifier channel has exceeded thermal limits.	Wait 10 to 15 minutes to let the unit cool. Press the <i>Standby</i> button. If the error message does not clear it is likely that your unit does not have adequate ventilation. Move the amplifier to a more open location to allow for ventilation. If that does not correct the problem, call your Mark Levinson dealer or Mark Levinson customer service.
WARNING: OVER CURRENT ON [LEFT/RIGHT] CHANNEL	Indicated amplifier channel has exceeded current limits.	Disconnect the AC power cord from the mains power source. Wait 10 seconds and reattach the power cord. If the error message does not clear disconnect the power cord again and disconnect the affected channel's speaker wire from the unit. Wait 10 seconds and reattach the AC power cord. If the error message does not clear call your Mark Levinson dealer or Mark Levinson customer service.

If your unit is connected to a home network, use a PC or tablet to access the N°5805 / N°5802's GUI via a web browser. On the right side of the Utility page, you will see a red bell icon with various status indicators, including operating temperature (shown in degrees Celsius). Note the indicators and open the "Fault History" file. This data may help you or a technician diagnose any amplifier malfunctions or adverse conditions.



NO POWER

Examine the power cord to ensure that it is connected to both the AC mains connector and a working, un-switched electrical outlet.

Check the mains fuse accessible on the rear panel mains outlet.

Examine the electrical circuit breaker to ensure that power is being supplied to the electrical outlet to which the N°5805 / N°5802 is connected.

Make sure the N°5805 / N°5802 is not in *Standby* mode. The front-panel standby LED illuminates fully and continually when the N°5805 / N°5802 is On. The LED flashes slowly when the N°5805 / N°5802 is in *Standby* mode.

REMOTE CONTROL DOES NOT OPERATE

Eliminate obstructions between the remote control IR transmitter and the IR receiver on the N°5805 / N°5802's front-panel display.

Check the menu to make sure the front panel IR was not disabled.

Make sure the rear-panel IR input connector is not being used.

Make sure the remote control is positioned within 17 feet (5m) and within a 45-degree angle of the N°5805 / N°5802's front panel.

Make sure the IR receiver on the N°5805 / N°5802's front-panel display is not exposed to intense sunlight, halogen light, or fluorescent light. This can cause IR reception to become unreliable.

Replace the remote control batteries.

NO SIGNAL AT THE SPEAKER OR LINE OUTPUTS

Examine all audio cables to ensure a reliable connection between the N°5805 / N°5802 and all associated components.

Examine the speaker cables to ensure a reliable connection between the N°5805 / N°5802 and the speakers.

Make sure that the connected speakers are working by connecting one of them to another amplifier (if available).

Make sure the volume is set to an audible level (start at 30 and move slowly up from there).

Make sure the mute is deactivated. The word "Mute" appears on the front panel display when in Mute mode. Push the Mute button to return to normal operation.

Make sure the Offset setting for the selected input is not reducing the volume to an inaudible level. See Setup/Input for more information.

Make sure all associated components are connected to working electrical outlets and powered On.

Make sure the source device connected to the selected N°5805 / N°5802 input is producing an output signal.

"MISSING" INPUT

Make sure the Name parameter for the selected input has not been set to Disabled in the *Setup* menu. (Refer to Setup/Inputs/ on page 18 for more information.)

AUDIO HAS A HUMMING SOUND

Disconnect components one at a time to isolate the problem.

Once you have identified the problematic component, make sure it is properly grounded and connected to the same electrical circuit as the N°5805 / N°5802.

VOLUME CAN'T BE SET TO MAXIMUM

You have the option of establishing a maximum volume level in the *Setup* menu. If this option is set, it can prevent the N°5805 / N°5802 from reaching the maximum volume level of 80.0. (Refer to *Setup/Volume/ MaxVol* on page 21 for more information.)

FRONT-PANEL DISPLAY NOT WORKING

Press any remote or front panel button to restore the display from the off mode. (Refer to *Setup/Display/Auto-Off* on page 22 for more information.)

NO CONNECTIVITY VIA ETHERNET

Verify that an Ethernet cable is correctly connected between the router, switch or hub and the N°5805 / N°5802.

Verify the age of the router, switch or hub. If the router, switch or hub is more than ten years old, there may be a communication issue with the N°5805 / N°5802. Power cycle the unit and use a newer router, switch or hub between the network and the N°5805 / N°5802.

IF ALL ELSE FAILS...

Power cycle the N°5805 / N°5802 by unplugging the power cord, waiting at least 10 seconds and reconnecting the power cord.

Restore factory-default settings (see *Setup/Advanced/Config/Restore* on page 26).

Contact your authorized Mark Levinson dealer.

Contact Mark Levinson Customer Service at 888-691-4171 or www.marklevinson.com.

SPECIFICATIONS

ANALOG LINE STAGE (N°5805 ONLY)

Line Input Impedance:	Balanced (XLR): 20k Ω ; Single-ended (RCA): 10k Ω
Volume Control:	Balanced; voltage mode; digitally-controlled resistor network
Gain:	8.5dB maximum
Output Impedance:	55 Ω
Output Overload:	>4.5V RMS
Frequency Response:	20Hz to 20kHz, \pm 0.03dB; <2Hz to 210kHz, +0.1/-3dB (At unity gain volume setting)
Total Harmonic Distortion:	<0.01%, 1kHz; <0.03%, 20 kHz; 2V RMS output (At unity gain volume setting)
Signal-To-Noise Ratio:	>96dB (20Hz to 20kHz, A-weighted); >93dB (20Hz to 20kHz, wideband, unweighted) (Referred to 2V RMS output, unity gain volume setting)
Input Sensitivity:	53mV RMS at line input for 2.83V RMS at speaker output, maximum volume setting
System Gain:	34.5dB, line input to speaker output, maximum volume setting

PHONO STAGE (N°5805 ONLY)

Riaa Frequency Response:	20Hz to 20kHz, \pm 0.3dB
Infrasonic Filter:	Selectable; 20Hz, 1st order (6dB/octave)

MOVING-MAGNET MODE

Input Resistance:	47k Ω
Input Capacitance:	Selectable; 20, 70, 120, 170pF
Gain:	39dB at 1kHz
Total Harmonic Distortion:	<0.01%, 1kHz, 2V RMS output; <0.05%, 20kHz, 2V RMS output
Signal-To-Noise Ratio:	>90dB (20Hz to 20kHz A-weighted, referred to 2V RMS output); >78dB (20Hz to 20kHz, wideband, unweighted, referred to 2V RMS output)
Maximum Input Level:	>190mV at 1kHz; >1.6V at 20kHz

MOVING-COIL MODE

Input Resistance:	Selectable, 37 Ω to 1000 Ω
Gain:	69dB at 1kHz
Total Harmonic Distortion:	<0.01%, 1kHz, 2V RMS output; <0.06%, 20kHz, 2V RMS output
Signal-To-Noise Ratio:	>71dB (20Hz to 20kHz A-weighted, referred to 2V RMS output); >66dB (20Hz to 20kHz, wideband, unweighted, referred to 2V RMS output)
Maximum Input Level:	>6.5mV at 1kHz; >19mV at 20kHz

DIGITAL-TO-ANALOG CONVERTER STAGE

Output Voltage:	5.7V RMS at maximum volume/full scale (0dBFS)
Frequency Response:	20Hz to 20kHz, +0/-0.05dB (44.1kHz/16 bit signal); 20Hz to 20kHz, +0/-0.02dB (192kHz/24 bit signal)
Total Harmonic Distortion:	<0.0025%, 20Hz to 20kHz, at 3V RMS output (192kHz/24 bit signal); <0.003%, 20Hz to 20kHz, at 3V RMS output (44.1kHz/16 bit signal); <0.006%, 90kHz, at 3V RMS output (192kHz/24 bit signal)
Signal-To-Noise Ratio:	>100dB (20Hz to 20 kHz, 192kHz/24 bit signal, A-weighted); >98dB (20Hz to 20 kHz, 192kHz/24 bit signal, wideband, unweighted); >94dB (20Hz to 20 kHz, 44.1kHz/16 bit signal, A-weighted); >92dB (20Hz to 20 kHz, 44.1kHz/16 bit signal, wideband, unweighted) Referred to 3VRMS output
Sample Rates/Bit Depth:	PCM: 32, 44.1, 48, 88.2, 96, 176.4, 192, 352.8, or 384kHz; up to 32 bits; DSD: Native or DoP; single, double, or quad speed (2.8, 5.6, or 11.2MHz)
Digital Processing:	Full MQA decoding; PCM: Seven user-selectable digital filter settings; user-selectable up-sampling to 352.8/384kHz; DSD: Four user-selectable digital filter settings

HEADPHONE OUTPUT

Total Harmonic Distortion:	<0.04%, 20Hz and 1kHz, 2V RMS output, 30 Ω load; <0.10%, 20kHz, 2V RMS output, 30 Ω load
Output Overload:	>3.3V RMS, 30 Ω load
Signal-To-Noise Ratio:	>91dB (20Hz to 20kHz, A-weighted, referred to 2V RMS output); >87dB (20Hz to 20kHz, wideband, unweighted, referred to 2V RMS output)
Output Impedance:	<2.5 Ω , 20Hz to 20kHz

AMPLIFIER SECTION

Frequency Response:	<2Hz to 20kHz, +0/-0.2 dB; <2Hz to 100kHz, +0/-3dB
Signal-To-Noise Ratio:	>103dB (20Hz to 20 kHz, A-weighted); >100dB (20Hz to 20 kHz, wideband, unweighted)
Total Harmonic Distortion + Noise:	<0.035% at 1kHz, 125W, 8Ω; <0.18% at 20kHz, 125W, 8Ω
Output Power:	125W RMS per channel at 8Ω, 20Hz to 20kHz
Output Impedance:	<0.098Ω, 20Hz to 10kHz; <0.11Ω at 20kHz
Damping Factor:	>82, 20Hz to 10kHz; >72 at 20kHz (All referred to 8Ω)

GENERAL

Analog Input Connectors (N ^o 5805 Only):	1 pair balanced line-level inputs (XLR); 2 pairs single-ended line-level inputs (RCA); 1 pair single-ended moving-coil phono inputs (RCA); 1 pair single-ended moving-magnet phono inputs (RCA)
Digital Audio Connectors:	2 optical digital inputs (Toslink); 1 asynchronous USB digital input (USB-B); N ^o 5805: 1 coaxial digital S/PDIF input (RCA); N ^o 5802: 2 coaxial digital S/PDIF input (RCA); N ^o 5802: 1 balanced digital AES/EBU input (XLR)
Output Connectors:	1 pair single-ended line-level outputs (RCA); 2 pairs loudspeaker outputs (High-current binding posts with banana sockets; accept spade lugs with ¼"/6.3mm spacing up to ⅜"/3mm thick)
Control Connectors:	1 RS-232 port (DB9 connector); 1 IR input (⅜"/3.5mm phone jack); 1 programmable 12V DC trigger output (⅜"/3.5mm phone jack), 100mA maximum; 1 programmable 12V DC trigger input (⅜"/3.5mm phone jack); 1 Ethernet port (RJ-45 connector)
Mains Voltage:	100VAC, 115VAC, or 230VAC, factory set
Power Consumption:	<i>Standby, "Green" mode:</i> <0.4W; <i>Standby, "Power Save" mode:</i> 7W; N ^o 5805: <i>Standby, "Normal" mode:</i> 70W; N ^o 5802: <i>Standby, "Normal" mode:</i> 45W; N ^o 5805: Power on, quiescent: 120W; N ^o 5802: Power on, quiescent: 95W; N ^o 5805: Power on, both channels at ⅓ rated power: 240W; N ^o 5802: Power on, both channels at ⅓ rated power: 215W; Power on, maximum: 500W
Dimensions/Weight (Unit):	Height: 5.72"/145mm; Height without feet: 5.25"/133mm; Width: 17.25"/438mm; Depth: 19.98"/507mm; Weight (N ^o 5805): 62 lbs/28.1kg; Weight (N ^o 5802): 61 lbs/27.6kg
Dimensions/Weight (With Packaging):	Height: 13.0"/330mm; Width: 24.0"/610mm; Depth: 28.0"/711mm; Weight (N ^o 5805): 73 lbs/33.0kg; Weight (N ^o 5802): 72 lbs/32.6kg



HARMAN International Industries, Incorporated
8500 Balboa Boulevard
Northridge, CA 91329 USA

© 2019 HARMAN International Industries, Incorporated. All rights reserved.

Mark Levinson is a registered trademark of HARMAN International Industries, Incorporated.

Other company and product names may be trademarks of the respective companies with which they are associated.

"MQA" is a trade mark of MQA Limited.

This document should not be construed as a commitment on the part of HARMAN International Industries, Incorporated. The information it contains, as well as the features, specifications and appearance of the product, is subject to change without notice. HARMAN International Industries, Incorporated, assumes no responsibility for errors that may appear within this document

For customer service and product shipment information, refer to our Website: www.marklevinson.com

Part No. 070-90062 rev. A.1

www.marklevinson.com